

TEMPERATURE CONTROLLER GUIDE

Thank you for purchasing Autonics product.

Before use, be sure to read the safety considerations and use them correctly.

Autonics

CONTENTS

Selecting Temperature Controllers	3
What is a Temperature Controller?	4
Control Types	4
Control Outputs	5
Alarm	6
Glossary	7
Proper Usage	8
APPENDIX	

Selecting Temperature Controllers

It is an element to select a temperature controller. Select the right product for each element for the most optimal detection.
You can check the details by referring to the contents.

1 Temperature control type Select the control type following to purpose of use

Indication only, ON/OFF, P/PI/PID control etc.

2 Operation type Select the operation type following to purpose of use

Standard, refrigeration type etc.

3 Shape Select the shape of product

Standard, modular, board, thumbwheel switch type etc.

4 Installation type Select the installation type

Panel, DIN rail etc.

5 Control output Select the control output

Relay, SSR, current etc.

6 Control type Select the control type

ON/OFF, P/PI/PID etc.

7 Input specification Select the input specification

Thermocouple, resistance temperature detector, analog etc.

8 Communication Select the communication type (connection, protocol)

Connection: RS485, RS422, Ethernet etc.
Protocol: PLC ladderless, Modbus RTU, ASCII etc

9 Option in/output Select whether option in/output support is available

CT input, digital input, transmission output, alarm output etc.

What is a Temperature Controller?

A temperature controller is an instrument that accepts electrical signals from a temperature sensor and sends a control signal to the manipulator through a built-in algorithm compared to the set value (SV).

The temperature sensor have a pipe-protected structure that converts the temperature into an electrical signal and is installed and used in the position where the temperature is to be detected.

An manipulator is a device that heats or cools a target according to the control signal transmitted from the temperature controller.

Control Types

ON / OFF control

If the present value is lower than the setting value, the output is turned ON and the heater power is supplied.

If the present value is higher than the setting value, the output is turned OFF and heater power is shut off. ON/OFF control operation is to ON/OFF heater power by comparing the present value and the setting value. ON/OFF control operation is not appropriate to optimal control due to overshoot and hunting.

Proportional control / band / control cycle

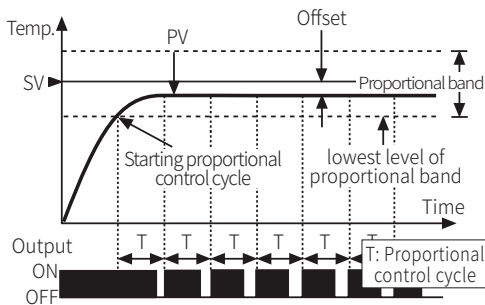

Proportional control adjusts the amount of output which is proportional to the variation in the set value and the current temperature in the specific temperature range (proportional band). Before the present value reaches lowest level of proportional band, control output is ON at 100%. When the present value exceeds it, the control output repeats ON/OFF operation in the proportional control cycle. P control minimizes hunting of ON/OFF control. However, P control has long time to reach the set value and offset.

Size of proportional band

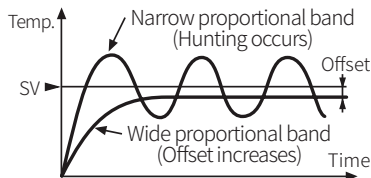

In case of wide proportional band, it takes long time to reach the present value (PV) to the set value (SV) and has wide offset because control output operates ON/OFF at more lower or higher temperature from the setting value.

In case of narrow proportional band, it takes short time to reach the present value (PV) to the set value (SV) and has hunting because control output operates ON/OFF at more near temperature to the setting value.

Integral action (I), Integral time

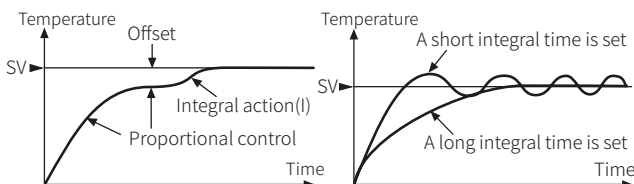

Integral action automatically adjusts the offset of proportional control to control stably at the setting value. However, it takes long time to stabilize the temperature changes about the external disturbances. Integral action cannot be operated by itself, it shall be operated with Proportional control. Reset time, the unit of intensity of integral action, is the taking time to coincide with the control output of integral action and the control output of proportional action.

The shorter reset time, the stronger integral action is. It adjusts offset for shorter time but causes hunting. But the longer reset time, the weaker integral action is. It takes longer time to remove offset.

Derivative action (D), Derivative time

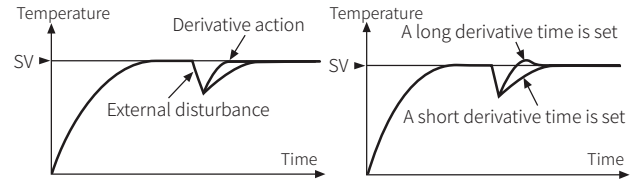

Derivative action is proportional to the slope of the temperature change to adjust the amount of operation. It stabilizes rapid temperature change due to the disturbance in a short period of time by rapid reaction.

Rate time, the unit of intensity of derivative action, is the taking time to coincide with the control output of the derivative action. The shorter rate time, the weaker derivation action responds slowly to external disturbances. Therefore, it takes longer time to reach the setting value but there is no hunting. But the longer rate time, the stronger derivation action response quickly to external disturbances. Therefore, it takes shorter time to reach the setting value but it is easy to occur in hunting.

PID control

PID control combined with proportional, integral, and derivation control modes has good control output to a controlled subject which has delay time.

PID control does not have overshoot and hunting of proportional control (P control), adjusts automatically offset of integral control (I control), and has fast response to external disturbance with derivative control (D control). As the result, PID control is realized optimal temperature control.

Auto tuning

Auto tuning measures the control subject's thermal characteristics and thermal response rate, and then determines the necessary PID constant automatically. The value can be customized after auto tuning is finished. During auto tuning, other parameters except auto tuning can not be changed but checked only. When auto tuning is stopped before finish by user or error, maintains PID constant before execution.

Offset, Manual reset

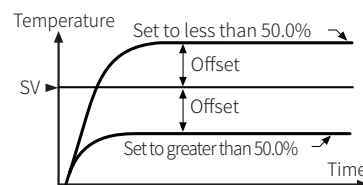

There is certain error despite stable operation status by the heat capacity of controlled subject, or the heating capability.

If the PV is lower than the SV after the control is stable, set the manual reset setting to greater than 50.0%, and if the PV is higher than the SV, set the setting to less than 50.0%.

Hysteresis

Perform ON and OFF actions within the interval (hysteresis) because the output is susceptible to oscillation or noise effects if the output is operated only at a set value. Generally, the compressor of the refrigerator should be subjected to excessive ON, OFF operation, so it is needed to set large hysteresis.

E.g.) If a temperature controller with temperature range of 0 to 400°C has 0.2 hysteresis (D=F.S. 0.2 to 3%), hysteresis (D) is 0.8°C. If the setting value is 100°C, the output is OFF at 100.4°C and it is ON at 99.6°C.

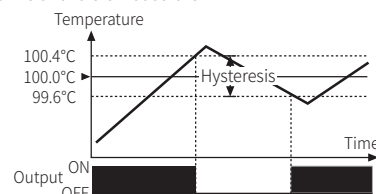

Control Outputs

Control output mode

Heating control

The output will be provided in order to supply power to the load (heater) if PV (Present Value) falls below SV (Set value).

Cooling control

The output will be provided in order to supply power to the load (cooler) if PV (Present Value) rises above SV (Set value).

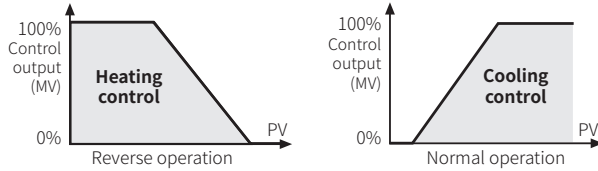

Heating & Cooling control

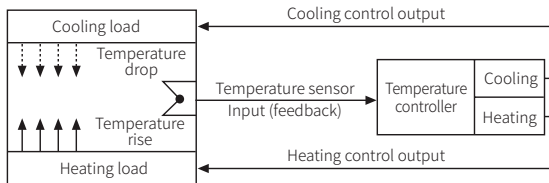

Heating and cooling with a single temperature controller when it is difficult to control subject temperature with only heating or cooling.

Heating and cooling control mode controls the object using different PID time constants for each heating and cooling. It is also possible to set heating and cooling control in both PID control or ON/OFF control mode. Heating/cooling output can be selected among Relay output, SSR drive output and current output depending on model types chosen according to your application environment.

Dead band, Overlap band

In heating & cooling control, it is possible to designate a dead band between heating & cooling control bands based on set value (SV).

If the dead band forms around the SV, no control occurs in the dead band area. If the dead band forms around the SV, heating and cooling control are performed at the same time.

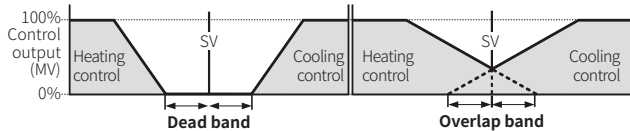

Output type

Relay

Relay output is used to control the ON/OFF operation of subject devices through the built-in relay contact.

SSR drive

SSR drive output releases DC voltage as an output to control SSRs (solid state relay: non-contact relay). Using solid state relays can help maintain a small configuration size and achieve a semi-permanent life cycle.

Current

A current output is a control output used to drive an external power controller (SCR UNIT), control valve, etc. It is also called analog output, and the output is stable and does not have rapid change, and it can process a stabilized control.

Transmission

It is not for controlling but for transmitting PV to outside. Generally, PV is transmitted as current. In case of transmission output DC 4-20mA, it outputs DC 4-20mA within the set high/low-limit range.

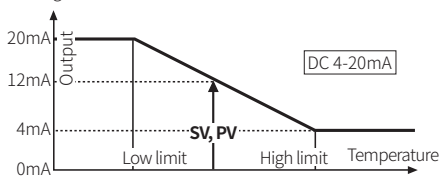

Output connection

Relay output connection

Keep A length as long as possible when wiring the temperature controller and the load. If wire length of 'A' is short, counter electromotive force which occurs from a coil of magnet switch & power relay may flow in power line of the unit, and it may cause malfunction.

If wire length of 'A' is short, please connect mylar condensers 104 (630 V) on the both ends of [MC] (magnet coil) to protect electromotive force.

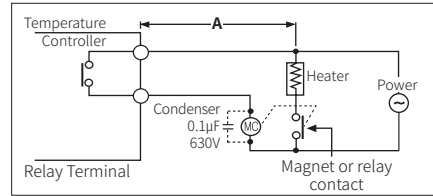

SSR output connection

When selecting cycle or phase control mode, the power supply for load and temperature controller must be the same.

SSR should be selected by the capacity of load, otherwise, it may short-circuit and result in a fire. Indirect heated should be used with SSR for efficient working. Please use a cooling plate or it may cause the capability deterioration, breakdown of SSR for a long usage.

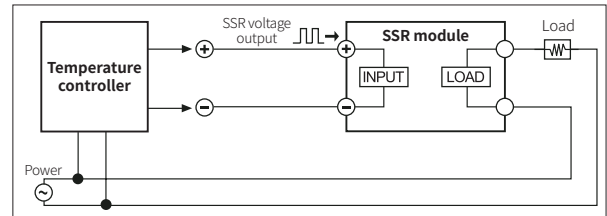

Alarm

■ Operation

• H: Alarm output hysteresis

Name	Alarm operation	Description
-	-	No alarm output
Deviation high limit		If deviation between PV and SV as high-limit is higher than set value of deviation temperature, the alarm output will be ON.
	High deviation: Set as 10°C High deviation: Set as -10°C	
Deviation low limit		If deviation between PV and SV as low limit is higher than set value of deviation temperature, the alarm output will be ON.
	Low deviation: Set as 10°C Low deviation: Set as -10°C	
Deviation high, low limit		If deviation between PV and SV as high/low-limit is higher than set value of deviation temperature, the alarm output will be ON.
	High, Low deviation: Set as 10°C	
Deviation high, low limit reverse		If deviation between PV and SV as high/low-limit is lower than set value of deviation temperature, the alarm output will be OFF.
	High, Low deviation: Set as 10°C	
Absolute value high limit		If PV is higher than the absolute value, the output will be ON.
	Absolute value: Set as 90°C Absolute value: Set as 110°C	
Absolute value low limit		If PV is lower than the absolute value, the output will be ON.
	Absolute value: Set as 90°C Absolute value: Set as 110°C	
Sensor break	-	It will be ON when it detects sensor disconnection.
Heater break	-	It will be ON when it detects heater disconnection.
Loop break	-	It will be ON when it detects loop disconnection.

■ Option

Name	Description
Standard alarm	If it is an alarm condition, alarm output is ON. If it is a clear alarm condition, alarm output is OFF.
Alarm latch	If it is an alarm condition, alarm output is ON and maintains ON status.
Standby sequence 1	First alarm condition is ignored and from second alarm condition, standard alarm operates. When power is supplied and it is an alarm condition, this first alarm condition is ignored and from the second alarm condition, standard alarm operates.
Alarm latch and standby sequence 1	If it is an alarm condition, it operates both alarm latch and standby sequence. When power is supplied and it is an alarm condition, this first alarm condition is ignored and from the second alarm condition, alarm latch operates.
Standby sequence 2	First alarm condition is ignored and from second alarm condition, standard alarm operates. When re-applied standby sequence and if it is alarm condition, alarm output does not turn ON. After clearing alarm condition, standard alarm operates.
Alarm latch and standby sequence 2	Basic operation is same as alarm latch and standby sequence 1. It operates not only by power ON/OFF, but also alarm set value, or alarm option changing. When re-applied standby sequence and if it is alarm condition, alarm output does not turn ON. After clearing alarm condition, alarm latch operates.

■ Sensor break alarm

The function that alarm output will be ON when the sensor is not connected or when sensor's disconnection is detected during temperature controlling. You can check whether the sensor is connected with buzzer or other units using alarm output contact.

■ Heater break alarm

The function that alarm output will be ON when the heater is not connected or when disconnection is detected. The current flow is converted to a constant ratio (CT ratio) by using the Current Transformer (CT), and then the temperature controller check it to detect whether a circuit is open.

■ Loop break alarm (LBA)

It checks control loop and outputs alarm by temperature change of the subject. For heating control(cooling control), when control output MV is 100%(0% for cooling control) and PV is not increased over than LBA detection band during LBA monitoring time, or when control output MV is 0%(100% for cooling control) and PV is not decreased below than LBA detection band during LBA monitoring time, alarm output turns ON.

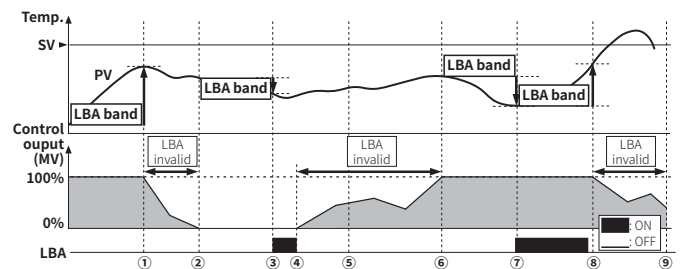

Start control to ①	When control output MV is 100%, PV is increased over than LBA detection band during LBA monitoring time.
① to ②	The status of changing control output MV (LBA monitoring time is reset.)
② to ③	When control output MV is 0% and PV is not decreased below than LBA detection band during LBA monitoring time, loop break alarm (LBA) turns ON after LBA monitoring time.
③ to ④	Control output MV is 0% and loop break alarm (LBA) turns and maintains ON.
④ to ⑥	The status of changing control output MV (LBA monitoring time is reset.)
⑥ to ⑦	When control output MV is 100% and PV is not increased over than LBA detection band during LBA monitoring time, loop break alarm (LBA) turns ON after LBA monitoring time.
⑦ to ⑧	When control output MV is 100% and PV is increased over than LBA detection band during LBA monitoring time, loop break alarm (LBA) turns OFF after LBA monitoring time.
⑧ to ⑨	The status of changing control output MV (LBA monitoring time is reset.)

• When executing auto-tuning, LBA detection band and LBA monitoring time are automatically set based on auto tuning value. When alarm operation mode is set as loop break alarm (LBA), LBA detection band and LBA monitoring time parameter is displayed.

■ **Temperature sensor**

Temperature can be simply classified into two groups, contact and non-contact. Most of sensors such as platinum resistance thermometer, thermistor, thermocouple, etc. are contact temperature sensors, and it literally contacts with object to infer the temperature.

■ **Platinum resistance thermometer (RTD: Resistance Temperature Detector)**

The electrical resistance of the metal used by platinum resistance thermometers has a fixed relationship to the temperature. Therefore, a platinum wire is used for the resistor. The most reproducible temperature sensor, platinum RTD has a near linear positive temperature coefficient from -260 to 630°C. In this reason, RTDs are used as industry standard.

Sensor is put in protecting tube charged with insulation and widely used for dyeing, physical/chemical appliances, controlling processor, but it is somewhat expensive.

■ **Thermistor**

A thermistor is a semiconductor device with an electrical resistance that is proportional to temperature, and there are two types, PTC (Positive Temperature Coefficient) and NTC (Negative Temperature Coefficient).

It is mostly used for assembling machines, inexpensive and small. But they are incompatible and non-linear.

And so circuits cannot be used for an industrial purpose or in circumstances where compatibility with sensor is required. NTC is used for temperature sensing/ controlling, liquid/wind/vacuum level detecting, inrush current preventing, retardation element, etc., and PTC is for motoring, degaussing, heating a fixed temperature, overcurrent device, etc.

■ **Thermocouple**

Thermo electromotive force is provoked when providing temperature for the junction of the difference metals which is joined and welding. This thermo electromotive force has the certain value depending on temperature changes.

Thermocouple sensor is generally used for industrial use such as the steel, power plant, or heavy chemical industry. However, thermocouple's accuracy is not higher than platinum RTD and thermocouple is able to be expensive than platinum RTD because thermocouple requires compensating lead wires.

• **Sheath thermocouple**

Sheathed thermocouple consists of sheath, and sealed insulator of high magnesiumium with element wire.

Sheathed thermocouple has fast response of temperature changes, high resistance, high corrosion-resistance, and high pressure-resistance.

- **Grounded**

Grounded type which is welded element wires and sheath directly has fast response. It is suitable to measure high temperature and pressure. However, it which is non insulated has a limit on various applications.

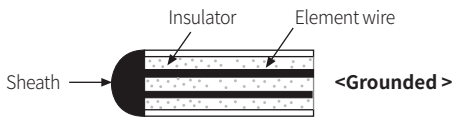

- **Ungrounded**

Ungrounded type which is completely insulated between element wires and sheath has slow response. However, it has small impact on external factors such as corrosion, high pressure, or high temperature. Due to this reason, it is suitable for prolonged use.

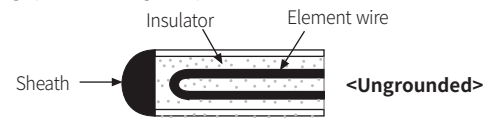

- **Exposed**

Exposed type which consists of exposed element wires to the sheath has the fastest response among three sheath types. However, it which has low mechanical intensity is not suitable for corrosive, high pressure, or high temperature environment.

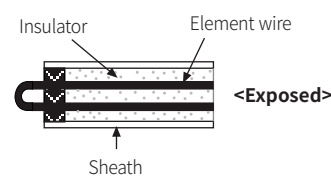

■ **Setting value (SV)**

SV is the target temperature set by user.

■ **Present value (PV)**

PV is present temperature of the object measured by temperature controller.

■ **Deviation**

The difference between the present value (PV) for the setting value (SV).

■ **Burn out**

The action of off the control output when the sensor is disconnected.

■ **Heat response**

The response time to the heat of the heater, usually expressed as a percentage.

$$\text{Heat response} = \frac{\text{Falling time}}{\text{Rising time} + \text{Falling time}} \times 100 (\%)$$

■ **Linearize**

It refers to correcting the non-linear response of the temperature sensor for the temperature change.

The analog temperature controller compensates for unevenness of the grid spacing, and the digital temperature controller is corrected using a linear analysis circuit.

■ **Cold junction compensating circuit**

When connecting a thermocouple and input terminal of temperature controller, thermo electromotive force is provoked on a point of contact between a thermocouple and input terminal metal. The thermo electromotive force causes a temperature error, and for correcting this the temperature of the point should be maintained 0°C. However, it is hard to be maintained at 0°C. Because of this reason, the point of contact has an individual temperature sensor to detect the temperature of the point. Sensing circuit subtracts this temperature for correcting error, and this circuit is called cold junction compensating circuit. Most of temperature controllers have integrated cold junction compensating circuit.

■ **Compensating lead wire**

These are compensating lead wires used when the temperature measurement point and the temperature controller are far apart.

■ **Purpose of compensating lead wire using**

The principle of thermocouple temperature sensor is that after joining and welding two difference metals, thermo electromotive force is provoked when providing temperature on the junction.

Thus, in case of the distance between the thermocouple and the temperature controller is too long, compensating lead wires are required. Using normal wire extension can cause an error, because a connecting point could be another sensor. For this reason, consider the construction and resistive value. The compensating lead wires consist of materials that match the potential difference of the thermocouple to be use.

■ **Polarity of compensating lead wire**

There are two wires, red color wire for phases and blue one for neutral (white or black).

Please note that, if compensating lead wire polarity is unmatched, it generates error. E.g.) Use K type thermocouple compensating lead wire for K type thermocouple.

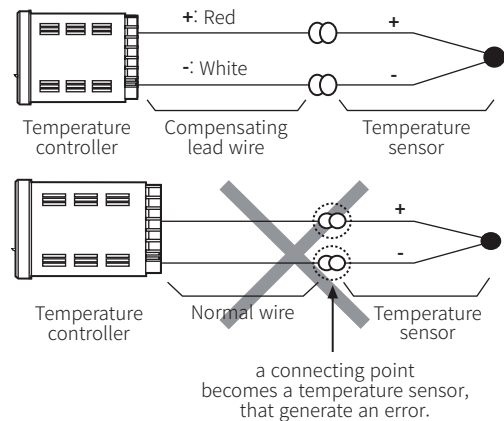

■ Caution during use (Common features)

- Use the regulated compensating lead wire only. Because a connecting point where normal wire and thermocouple wire joined together could be another sensor, using normal wire for extension can cause an error.
- 3-wire circuit connection is required for RTD sensor. Compensating wire that is the same length and diameter as the sensor wire is compulsory in using RTD sensor. Two different metal wires cause two different temperature values.
- Input signal wire is needed to be placed in an area that does not get much noise from wires around such power, loads, etc.
- If it is unavoidable for input signal wire to be placed near power line, line-filter capacitors are required to be set at power line of controller, and use shield wire for signal input line.
- Avoid using near devices that make high frequency noise (high frequency welder/ sewing machine, large-capacity SCR controller).

■ Simple "error" diagnosis

Incorrect temperature indicated.

Inspect input part in priority in this case. To find out at which part has problems if using thermocouple, disconnect the sensor from input terminal and check if it shows the room temperature on the display. And also, if using RTD type, make sure that if all the wires are 3-wire, the same diameters. Using 2-wire or 3-wire that different diameter, temperature deviation occurs.

Controlled temperature differs from SV when operation finished

Thermal response time of heater or controlled subject could be the problem in this case. Rearrange Reset VR on the front side of controller so that the deviation disappears.

Oscillating output relay

Which happens when back electromotive force generated from external magnet S/W comes in through power line or strong high-frequency device is being used nearby. Be far away from high-frequency devices. And stay two power lines, magnet S/W power's and controller's, apart from each other. If it is hard to rearrange track, add mylar condenser, 0.1 μ F/600 V or 1 μ F/600 V, on power terminal of external magnet S/W to remove oscillating.

Being observed right temperate in a room temperature but wide temperature deviation occur in high temperature

Check out if the sensor type is correspond with temperature controller. (It can be the problem of sensor characteristics)

APPENDIX

Safety Certification for Product and Component	III
Communication Standards	V
IP Code (protection against dust and water)	VI

Safety Certification for Product and Component

- For detailed certification information, visit the website of each certification body.
- For the status of certification on our product, visit the Autonics website.

■ CE

- Country: European Union



CE marking is the conformity marking, meaning that it complies with all Directives of the Council of European Union regarding safety, health, environmental, and consumer protection standards.

If a product judged to be a risk to the consumer's health, safety, and environmental protection, is sold in the European market, the CE mark must be affixed. It is an essential certification for entry into the European market.

■ UL Listed

- Country: United States



UL listing is the American standard for safety. It is a non-mandatory standard, but most States mandate this standard. This certification is highly favored by consumers.

UL Listed Mark means the end product meets standards of safety.

■ TR CU

- Country: Eurasian Economic Union



The EAC certification is accredited by five member countries of the Eurasian Economic Union (EAEU): Russia, Kazakhstan, Belarus, Armenia, and Kyrgyzstan.

Regulated products without the EAC mark are prohibited to access the markets of 5 members of EAEU.

- Type of certification
: Certificate of Conformity (CoC),
Declaration of Conformity (DoC)

■ KC

- Country: Republic of Korea



The KC certification mark must be affixed on an imported or domestically manufactured electrical product that is to be distributed or sold in Korea.

Type of certification: safety certification, EMC certification

- Safety certification: Korean Agency for Technology and Standards (KATS) affixes and manages the KC certification mark for electrical appliances, household goods, and children's products by dividing the steps into safety certification / safety confirmation / supplier's declaration of conformity (SODC) according to the different levels of potential danger.
- EMC certification: Manufacture, sale, or import for equipment that may cause harm to the radio environment and broadcasting communication network, or that may cause or receive significant electromagnetic interference, the KC certification mark is issued through electromagnetic compatibility (EMC) testing.

■ S-Mark

- Country: Republic of Korea



The S-Mark is the optional certification system to prevent industrial accidents. Korea Occupational Safety and Health Agency (KOSHA) conducts a comprehensive evaluation for the safety and reliability of product, and the capability of quality control in manufacturing.

Due to non-mandatory, there is no regulation or disadvantage on the uncertified product.

■ UL Recognized

- Country: United States



UL listing is the American standard for safety. It is a non-mandatory standard, but most States mandate this standard. This certification is highly favored by consumers.

UL Recognized Mark means the components intended for use in a complete product or system meet standards of safety.

■ KCs

- Country: Republic of Korea



The Minister of Employment and Labor evaluates the safety of hazardous or dangerous machinery, equipment, facilities, protective devices, and protective equipment based on the 'safety certification standards.' Occupational Safety and Health Agency (Ulsan, in South Korea) certifies safety through comprehensive tests complying with the 'safety certification standards.'

Any person who intends to manufacture, import, or change major structural parts of products subject to safety certification, must obtain this certification.

■ TUV NORD

- Country: Germany



TUV is a leading German private certification body that has been responsible for many testing and certification tasks related to safety in the industry for a long time. It is intended to protect people and property from fire and other accidents. Currently, TUV is conducting tests and inspections on safety and quality in various industries such as machinery, electronics and electricity, automobiles, chemical facilities, nuclear power, and aircraft. It is voluntary standards, and certification is issued complying with various EU Directives and German safety regulations.

■ Metrology Certification

- Country: Russia



Metrology Certification is a certificate for measuring and test equipment. Registration of measuring equipment is currently being revised and implemented following the Russian Federal Law, and is managed and supervised by the measurement authority, which is the subject of the certification. Measurement authorities review and test measuring equipment to be used in the Russian Federation based on the State System of Measurement (SSM), issue certificates, and manage them in the government's online database for users and buyers to browse.

■ CCC

- Country: China



The China Compulsory Certificate system (CCC) is a compulsory mark for products that met Chinese technical standards and are allowed to be imported by the Chinese government. Foreign-imported industrial products are examined through CCC certification process whether they meet safety standards or not. The certified products are distributed and sold with the CCC mark or factory code according to the product. CCC certification is administered by the China Quality Certification Center (CQC).

■ PSE

- Country: Japan



PSE is a compulsory certification administered by the Ministry of Economy, Trade and Industry (METI) and governs by the Electrical Appliances Safety Law in Japan. The purpose is to minimize the occurrence of harm and damage caused by electrical equipment by regulating the manufacture and sale of electrical appliances and bring an engagement of the private sector to ensure the safety of electrical appliances. Manufacture, import, and sell electrical appliances in the Japanese market, the technical standards for those products must be satisfied and the PSE certification mark must be displayed.

■ GOST

- Country: Russia



GOST is national technical standards set by the Euro Asian Council for Standardization, Metrology and Certification (EASC). The abbreviation GOST stands for GOSudarstvennyy STandart, which means State Union Standard in Russian. The current GOST standard includes over 20,000 titles and is widely used in common in the Commonwealth of Independent States (CIS) (12 countries). All countries of the CIS currently adopt and use the GOST standard, but the certificates issued by each country and the subject of the issuing certification body are different, so each country's GOST certificate can be regarded as a different certificate. The national standards of Russia are the GOST R, those of Kazakhstan are GOST K, etc.

■ China RoHS

- Country: China



China RoHS is the Chinese government regulation to control and eliminate the environmental impact of toxic and hazardous substances and elements in electrical/ electronic equipment. China's Measures for the Administration of the Control of Pollution by Electronic Information Products like the EU RoHS Directive have been enacted, and regulate additional hazardous substances compare to EU RoHS. Marking a logo or label for marking information is mandatory. In addition, there is a certification system before selling the product to ensure its conformity by conducting test analysis. Products to be exported to China will be screened prior to customs entry. Customs entry is only permitted for products that meet conformance standards.

Communication Standards

- For detailed information on communication, visit the related association's website.

■ EtherNet/IP

EtherNet/IP™

EtherNet/IP is an industrial network protocol that conforms Common Industrial Protocol to standard Internet. It is one of the leading industrial protocols in the United States and is widely used in a variety of industries, including factories.

EtherNet/IP and CIP technologies are managed by ODVA, Inc., a global trade and standards development organization founded in 1995 with over 300 corporate members.

EtherNet/IP uses the most widely adopted Ethernet standards - Internet Protocol and IEEE 802.3 - to define functions for the transport, network, data link, and physical layer. CIP uses object-oriented design to provide EtherNet/IP with services and device profiles needed for real-time control and to promote consistent implementation of automation functions across a diverse ecosystem of products.

■ DeviceNet

DeviceNet

DeviceNet is a digital multidrop network to interconnect industrial controllers and I/O devices. DeviceNet provides users a cost-effective network for distribution at no cost, deploys and manages simple devices across the architecture.

DeviceNet uses CAN (Controller Area Network), a network technology used in automobile vehicles, for its data link layer, and this network is used in almost all industries. DeviceNet is approved by CENELEC for its official standard and is also used as a global standard.

■ ProfiNet



PROFINET, designated and announced by PI (PROFIBUS & PROFINET), is the open standard for industrial Ethernet in automation technology. It provides solutions for process automation, factory automation and motion control. It enables the integration of existing fieldbus systems such as PROFIBUS, Interbus and DeviceNet into an open Ethernet-based network. PROFINET, the protocol for communication, configuration and diagnosis in the network, uses Ethernet standard as well as TCP, UDP, IP. It achieves fast and safe data exchange, enabling the concepts of innovative machine and plant. Thanks to its flexibility and openness, PROFINET offers the users a freedom in building machine and plant architectures and significantly increases plant availability by optimal use of resources available to users.

■ CC-Link



CC-Link is the open field network and the global standard with SEMI certification. As high-speed field network, CC-Link can process both control data and information data at the same time. With a high communication speed of 10 Mbps, it supports a transmission distance of 100 meters and connects to 64 stations.

It achieved high-speed response of up to 10 Mbps, guaranteeing punctuality. With CC-Link, complex production lines can be simplified and built at low cost. There are advantages of reducing the cost of wiring components, shortening the wiring construction period, and improving maintainability.

CLPA provides a memory map profile that allocates data for each product type. CC-Link compatible products can be developed based on this profile, and users can use the same program for connection and control even if existing product is replaced to other vendors' one.

■ EtherCAT



EtherCAT (Ethernet for Control Automation Technology) is an Ethernet-based fieldbus system developed by Beckhoff Automation. After releasing the technology from ETG (EtherCAT Technology Group) in 2003, it is standardized in IEC 61158 since 2007. It is a communication method that uses the frame according to IEEE 802.3 and physical layer and is an Ethernet protocol-based automation software that requires low jitter, short cycle time, and reduced hardware cost.

EtherCAT supports almost all topologies which have the advantage of flexibility and user-friendly. Due to the high-speed network, EtherCAT is suitable for applications requiring simultaneous operation.

■ HART



HART is the global standard for digital information communication via analog wires between smart devices and control or monitoring systems.

It is the duplex communication protocol and supports various analog I/O modules with HART connection. It sends and receives digital information through 4-20 mA current. It provides a reliable and long-term solution for plant operators who seek the benefits of smart devices with digital communication while maintaining existing facilities for analog instrumentation and plant wiring. Many sites that have applied the HART protocol can access to many digital process, maintenance and diagnostic information.

■ ProfiBus



ProfiBus is the open standard commonly used for process automation in the production site.

- Configuration
 - Master: It determines data traffic, transmits messages, and performs as role of Active Station.
 - Slave: It means I/O devices, valves, motor drivers, transmitters, etc. Slave receives a message and transmits the message depending on the Master's request.
- Up to 124 slaves and 3 masters can be connected to one communication line, and the communication method uses the half duplex method. Each device is connected to the bus in parallel and each device has its network address, so the installation location is irrelevant. Each device can be moved or removed during the communication.







IP Code (protection against dust and water)

IEC (International Electro-technical Commission) Standard



The IP Codes are defined in the IEC standard 60529.



1 Degree of protection against dust (protected from solid foreign objects)

Numeral	Degree of protection	Degree of protection
0	Non-protected	
1		Protection against the objects with 50 mm diameter or more. The object probe, sphere of 50 mm diameter, must not fully penetrate. - Test means : Rigid sphere without handle or guard. - Test force: 50 N ± 10%
2		Protection against the objects with 12.5 mm diameter or more. The object probe, sphere of 12.5 mm diameter, must not fully penetrate. - Test means : Rigid sphere without handle or guard. - Test force: 30 N ± 10%
3		Protection against the objects with 2.5 mm diameter or more. The object probe, sphere of 2.5 mm diameter, must not fully penetrate. - Test means : Rigid steel rod with edges free from burrs. - Test force: 3 N ± 10%
4		Protection against the objects with 1 mm diameter or more. The object probe, sphere of 1 mm diameter, must not fully penetrate. - Test means : Rigid steel rod with edges free from burrs. - Test force: 1 N ± 10%
5		Protection against the dust with or without pressure. - Dust-protected enclosures allow a limited quantity of dust to penetrate; complete protection against contact. Test duration: 8 hours Dust (the talcum powder) : It must be able to pass a square-meshed sieve that its nominal wire with 50 µm diameter; the nominal width of a gap between wires 75 µm. The amount of talcum powder: 2 kg/m ³
6		Protection against the dust under pressure. - Dust-tight enclosures do not allow any dust to penetrate. Test duration : 2 hours (a volume of dust: 40 to 60 / hour) 8 hours (a volume of dust: less than 40 / hour) Depression : Less than 2 kPa (20 mbar) on the manometer. Dust (the talcum powder) : It must be able to pass a square-meshed sieve that its nominal wire with 50 µm diameter; the nominal width of a gap between wires 75 µm. The amount of talcum powder: 2 kg/m ³

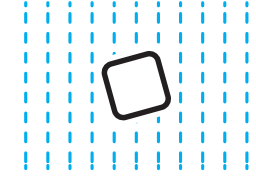
2 Degree of protection against ingress of water (protected from liquids)

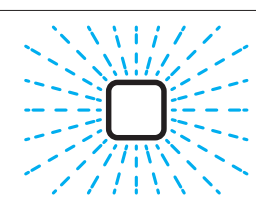
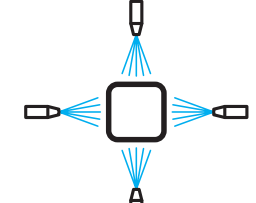
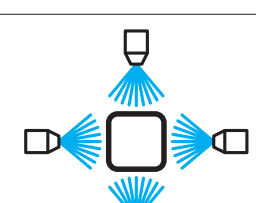
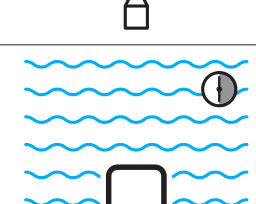
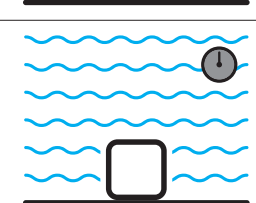
Numeral	Degree of protection	Degree of protection
0	Non-protected	
1		Protection against vertically falling water drops. Water drops flow over the whole area of four sides on a fixed and tilting enclosure. - Test duration : 10 min (2.5 min in each of four sides)
2		Protection against vertically falling water drops when the enclosure is tilted up to 15° from its normal position. Uniform flow of water drops over the whole area of the enclosure. - A rotation speed of turntable: 1r / min - Test duration: 10 min
3		Protection against spraying water at an angle up to 60° on either side of the vertical. The oscillating tube has spray holes over an arc of 60° either side of the center point. It sprinkles through an angle of 120° and 60° on either side of vertical. Then, the enclosure is turned through a horizontal angle of 90°, and continue the test for 5 min. - Test duration : 10 min (5 min in each of sides) - Mean flow rate per hole: 0.07 L/min
4		Protection against splashing water from any direction. - No harmful effects on the product. The oscillating semicircle tube with spray holes sprinkles through an angle of 360°. - Test duration: 10 min - Mean flow rate per hole: 0.07 L/min
5 ⁰¹⁾		Protection against projecting water in jets from any direction. - No harmful effects on the product. Spraying a stream of water from the test nozzle (internal diameter: Ø 6.3 mm) at all directions. - Test duration: 3 min - Distance from nozzle to enclosure surface : 2.5 to 3 m - Delivery rate: 12.5 L/min ± 5%
6 ⁰¹⁾		Protection against powerfully projecting water in jets from any direction. - The product is hermetically sealed. Spraying a stream of water from the test nozzle (internal diameter: Ø 12.5 mm) at all directions. - Test duration: 3 min - Distance from nozzle to enclosure surface : 2.5 to 3 m - Delivery rate: 100 L/min ± 5%
7 ⁰²⁾		Protection against temporary immersion in water under defined conditions of pressure and time. - The product is hermetically sealed. Immersion in water under defined conditions - Test duration: 30 min - Water level: 1 m
8 ⁰²⁾		Complete protection against continuous immersion in water. - The product is hermetically sealed. Immersion in water under defined conditions. - Test duration: more than 8 hours - Water level: 10 m

01) The degree of protection against spraying does not guarantee the effects of immersion.

02) The degree of protection against immersion does not guarantee the effects of spray.

■ DIN (Deutsche Industrie Normen) Standard

The DIN standard is defined in the DIN 40050-9.

IP 1 2

1 Degree of protection against dust (protected from solid foreign objects)

Same as IEC standard

2 Degree of protection against ingress of water (under high temperature and high pressure)

Letters	Degree of protection	
9K	Water resistance under high temperature and high pressure	Protection against high-temperature vapor and high-pressure water at all directions. - No harmful effects on the product.

■ JEM (Japan Electrical Manufacturers' Association) Standard

The JEM standard is defined in the JEM 1030.

IP 1 2 3

1 Degree of protection against dust (protected from solid foreign objects)

Same as IEC standard

2 Degree of protection against ingress of water (protected from liquids)

Same as IEC standard

3 Degree of oil proof / oil resistance

Letters	Degree of protection	
F	Oil proof type	Protection against oil drop and oil powder in all directions - Even if oil penetrates in the product, it operates normally.
G	Oil resistant type	Protection against oil drop and oil powder in all directions - Special coating prevents penetration of oil into the product.

Autonics

www.autonics.com

Dimensions or specifications on this manual are subject to change and some models may be discontinued without notice.