

User Manual

Recorder

KRN100 Series

MCR-KRN100U1-V1.2-US

Thank you for purchasing an Autonics product.
This user manual contains information about the product and its proper use,
and should be kept in a place where it will be easy to access.

Preface

Thank you very much for selecting Autonics products.

Please familiarize yourself with the information contained in the **Safety Considerations** section before using this product.





This user manual contains information about the product and its proper use, and should be kept in a place where it will be easy to access.

User Manual Guide

This user manual contains information about the product and its proper use, and should be kept in a place where it will be easy to access.

- Please familiarize yourself with the information in this manual before using the product.
- This manual provides detailed information on the product's features. It does not offer any guarantee concerning matters beyond the scope of this manual.
- This manual may not be edited or reproduced in either part or whole without permission.
- A user manual is provided as part of the product package.
Visit our home-page (www.autonics.com) to download a copy.
- The manual's content may vary depending on changes to the product's software and other unforeseen developments within Autonics, and is subject to change without prior notice.
- We contrived to describe this manual more easily and correctly. However, if there are any corrections or questions, please notify us these on our homepage.

User Manual Symbols

Symbol	Description
 Note	Supplementary information for a particular feature.
 Warning	Failure to follow instructions can result in serious injury or death.
 Caution	Failure to follow instructions can lead to a minor injury or product damage.
 Ex.	An example of the concerned feature's use.
※1	Annotation mark.

Safety Considerations

- Please observe all safety considerations for safe and proper product operation to avoid hazards.
- Safety considerations are categorized as follows.

 Warning	Warning	Failure to follow these instructions may result in serious injury or death.
--	----------------	---

 Caution	Caution	Failure to follow these instructions may result in personal injury or product damage.
--	----------------	---



Warning

- Fail-safe device must be installed when using the unit with machinery that may cause serious injury or substantial economic loss. (e.g. nuclear power control, medical equipment, ships, vehicles, railways, aircraft, combustion apparatus, safety equipment, crime/disaster prevention devices, etc.)
Failure to follow this instruction may result in personal injury, economic loss or fire.
- Do not connect, repair, or inspect the unit while connected to a power source.
Failure to follow this instruction may result in fire or electric shock.
- Check 'Connections' before wiring.
Failure to follow this instruction may result in fire.
- Do not touch the product during operation or for a certain period of time after stopping.
Failure to follow this instruction may result in burn or fire.
- Do not use the unit in the place where flammable/explosive/corrosive gas, high humidity, direct sunlight, radiant heat, vibration, impact, or salinity may be present.
Failure to follow this instruction may result in explosion or fire.
- Install on the device panel or DIN rail, and ground to the F.G. terminal separately.
When connecting the F.G. terminal, use AWG16(1.25mm²) or over.
Failure to follow this instruction may result in fire or electric shock.
- Do not disassemble or modify the unit.
Failure to follow this instruction may result in fire or electric shock.
- Since Lithium battery is embedded in the product, do not disassemble or burn the unit.
Failure to follow this instruction may result in fire.

**Caution**

- Use the unit within the rated specifications.
Failure to follow this instruction may result in fire or product damage.
- Use a dry cloth to clean the unit, and do not use water or organic solvent.
Failure to follow this instruction may result in fire or electric shock.
- Keep the product away from metal chip, dust, and wire residue which flow into the unit.
Failure to follow this instruction may result in fire or product damage.
- When connecting the power input or measurement input, use AWG20(0.50mm²) cable or over and tighten the terminal screw with a tightening torque of 0.74 to 0.9N·m.
Failure to follow this instruction may result in fire or malfunction due to contact failure.
- Do not use the load beyond rated switching capacity contact.
Failure to follow this instruction may result in fire, relay broken, contact melt, insulation failure or contact failure.
- Do not disassemble or assemble input/output card, when power is supplied.
Failure to follow this instruction may result in product damage.
- Use the transmitter output terminals only as the power for the transmitter.
Failure to follow this instruction may result in product damage.
- When connecting the temperature sensor(TC, RTD) or analogue input (voltage, current) as input to the universal input card, set the jumper pin to the correct place for the connected input method.
If the jumper pin is placed improperly, it may result in product damage or malfunction.

※**The specifications and dimensions of this manual are subject to change without notice.**

※**Be sure to follow cautions written in the instruction manual and the technical descriptions (catalog, website).**

Table of Contents

Preface	ii
User Manual Guide	iii
User Manual Symbols	iv
Safety Considerations	v
Table of Contents	vii
1 Overview	11
1.1 Feature of KRN 100	11
1.2 Component and sold separately	12
1.2.1 Component	12
1.2.2 Accessory	12
1.3 Ordering information	13
1.4 Part description	15
1.4.1 Front and side part	15
1.4.2 Back side	17
1.4.3 Inside	18
1.4.4 Paper cassette	18
2 Specification	19
2.1 KRN100	19
2.2 I/O card	21
2.3 Input specification and measuring range	23
3 Dimensions	24
4 Connection	26
4.1 KRN100	26
4.2 I/O card	27
5 Installation	29
5.1 Installation place	29
5.2 Installation	30
5.2.1 Bracket mounting	30
5.2.2 Additional I/O card connection	31
5.3 USB to Serial driver	32
5.3.1 Driver installation	32
5.3.2 Checking driver	34
6 Display	35
6.1 Initial booting screen	35
6.2 Screen layout	36
6.2.1 Status display	36
6.2.2 Virtual keyboard	39
6.2.3 Parameter setting display	40
7 Operation	41

7.1	Screen display	41
7.1.1	Measuring value display	41
7.1.2	Channel switch	43
7.2	Special operation for record	45
7.3	Parameter setting group	46
7.3.1	Parameter setting	46
7.3.2	QUICK MENU	47
7.3.3	Parameter	51
8	Parameter detail setup	53
8.1	INPUT SETUP(Input setting)	53
8.1.1	Select UI Card (Select universal input card)	55
8.1.2	Input Set Copy (Copy input parameter)	55
8.1.3	LCD/Paper Record (Display and record measuring value)	56
8.1.4	Pen Color (Record color)	56
8.1.5	Record Zone (Record zone)	56
8.1.6	Tag Name (Channel name)	57
8.1.7	Input Type (Input specification)	57
8.1.8	Range/Scale Point (Decimal point)	58
8.1.9	Display/Temp Unit (Display unit/Temperature unit)	59
8.1.10	High/Low Range & Graph Scale(Upper/Lower limit input value and graph scale value)	60
8.1.11	Low Scale/High Scale (Lower limit/Upper limit scale value)	61
8.1.12	Special Function (Special function)	63
8.1.13	Reference Channel (Reference channel)	66
8.1.14	Input Bias(Error correction)	67
8.1.15	Span (Gradient adjustment)	67
8.1.16	Record Method (Data storage method)	69
8.1.17	Filter Type (Input digital filter)	69
8.1.18	Filter Counter (The number of digital filter)	70
8.1.19	Burnout Action (Display setting for break)	71
8.2	ALARM SETUP (Alarm setting)	72
8.2.1	Select UI Card (Select universal card input)	73
8.2.2	Alarm Set Copy (Copy alarm parameter)	73
8.2.3	Alarm□ Type(Alarm□ operation mode)	74
8.2.4	Alarm□ Ref Channel(Alarm□ reference channel)	76
8.2.5	Alarm□ Option(Alarm□ option)	77
8.2.6	Alarm□ Value(Alarm□ set value)	78
8.2.7	Alarm□ Hysteresis(Alarm□ hysteresis)	79
8.2.8	Alarm□ ON/OFF Delay(Alarm□ ON/OFF output delay time)	80
8.2.9	Alarm□ Alarm No(Alarm□ output alarm number)	81
8.2.10	Select Alarm Card(Select alarm output card)	81
8.2.11	Alarm-□ Status(Relay and transistor output method)	82
8.3	DIGITAL INPUT SETUP(Digital input setting)	83
8.3.1	Select DI Card (Select digital input card)	84
8.3.2	DI-□ Type (Select digital input □)	85
8.3.3	DI-□ Reset No (Reset alarm number)	86
8.3.4	DI-□ Status (Operation status)	86
8.4	COMMUNICATION SETUP (Communication setting)	87
8.4.1	Modbus Address (Communication address)	90

8.4.2	RS485 Port (Use RS485 communication)	90
8.4.3	Baud Rate (Baud rate)	90
8.4.4	Parity Bit (Communication parity bit)	91
8.4.5	Stop Bit(Communication stop bit)	91
8.4.6	Termination Set (Terminating resistance)	91
8.4.7	Response Wait Time (Communication response wait time)	92
8.4.8	Protocol (Communication protocol)	92
8.4.9	RS485 Com Write (RS485 communication write)	92
8.4.10	Ethernet Port (Use Ethernet communication)	93
8.4.11	IP Address (IP address)	95
8.4.12	Subnet Mask (Subnet Mask)	95
8.4.13	Default Gateway (Default gateway)	95
8.4.14	Ethernet Com Write (Ethernet communication write)	96
8.4.15	USB Device Port (Use USB communication)	96
8.4.16	USB Com Write (USB communication write)	96
8.5	RECORD SETUP (Record setting)	97
8.5.1	Record Mode (Recode mode)	98
8.5.2	Digital Print type(1 line record channel during numeric recording)	99
8.5.3	Standard Speed (Standard record speed)	100
8.5.4	Option Speed (Option record speed)	100
8.5.5	Memo Period (Digital memo period)	101
8.5.6	Divide Zone (Record zone division)	103
8.5.7	Standard Period (Standard record period)	104
8.5.8	Option Period (Option record period)	104
8.5.9	Listing Language (Language for list output)	105
8.5.10	Alarm Speed (Alarm record speed)	106
8.5.11	Power On Status (Record status when power ON)	106
8.5.12	Run Status (List printing at start recording)	107
8.5.13	List Out Option (List record option)	108
8.5.14	Zone Dot Line Distance (Dot line for zone division)	109
8.5.15	CH Print Distance (Record interval for each channel graph)	109
8.5.16	Start Line Print (Start line when starting record)	110
8.5.17	Range Print Time (Input range record period)	110
8.5.18	PenX(color) ON Time (Ink cartridge point delay time)	111
8.6	SYSTEM SETUP (System setting)	112
8.6.1	Device Name (Device name)	112
8.6.2	Date/Time (Date/Time)	113
8.6.3	Date Type (Date type)	113
8.6.4	Summer Time (Summer time)	113
8.6.5	Summer Time Period (Summer time period)	114
8.6.6	Alarm Sound (Alarm sound)	114
8.6.7	Sampling Rate (Sampling period)	114
8.6.8	Log Speed (Save period)	115
8.6.9	Backlight (LCD backlight brightness)	115
8.6.10	Backlight On/Off (LCD backlight ON method)	115
8.7	RESERVATION SETUP (Reservation setting)	116
8.7.1	Reservation Type (Reservation record)	116
8.7.2	Reservation Period (Reservation record period)	117
8.7.3	Reservation Time (Reservation record time)	118
8.8	FILE/MEMORY SETUP(File/Memory setting)	119

8.8.1	Load Set File (Open parameter setting file)	120
8.8.2	Save Set File (Save parameter setting file).....	120
8.8.3	Memory Status (Memory capacity)	121
8.8.4	Memory Clear (Delete memory).....	121
8.8.5	USB LogData Save (USB storage function).....	122
8.8.6	Memory Save Option (Memory storage option)	123
8.8.7	USB Memory Copy/Move (Move/Copy data)	124
8.9	USER INFORMATION SETUP(User information setting).....	125
8.9.1	Password (Password mode)	126
8.9.2	Login Admin (Administrator log in)	127
8.9.3	Change Admin Password (Change password by administrator)	127
8.9.4	User Lock (Change user authority)	128
8.9.5	Information (Check system information)	128
8.9.6	Firmware Upgrade (Firmware upgrade).....	129
8.10	RECORD BACKUP_ SETUP (Backup data record setting)	131
8.10.1	Record Backup (Backup data record).....	132
8.10.2	Backup Data List (Backup data list)	132
8.10.3	Start Date and Time (Start time for data storage)	133
8.10.4	End Date and Time (End time for data storage).....	133
8.10.5	Backup Print Mode (Backup data record mode)	133
8.10.6	Select Print Mode (Backup data recording mode setting).....	134
9	DAQMaster.....	136
9.1	Overview	136
9.2	Features.....	137
9.3	DAQMaster Function Comparison Table by Version.....	139
9.4	Dedicated KRN100 functions	140
9.4.1	Record Backup.....	140
9.4.2	User unit setting	141
9.4.3	Boot logo image setting.....	142
9.4.4	Backup data checking function	143
10	Maintenance	145
10.1	Ink cartridge replacement	145
10.2	Recording paper replacement	146
11	Troubleshooting	149
11.1	Error message	150

1 Overview

1.1 Feature of KRN 100

KRN100 is 100mm hybrid recorder with dot. It combines functions of paper recorder and paperless recorder by saving function with an USB memory (the world's first) and by adopting Trend graph, Bar graph, digital number display function through graphic LCD.

KRN100 enables to print the saved data of system memory as data backup function when run out of recording paper. KRN100 improves convenience by parameter setting, data transmission through RS485 and Ethernet communication (USB device is only for parameter setting), and backup data logger function.

It also adopts slot type input, output card to connect option card up to 12 channels. It supports several communication types, of course, and graphic user interface(GUI) with graphic display for easire and convenient use.

- Combines functions of paper recorder and paperless recorder
- Enables to print the saved data of inner memory when run out of recording paper (Data logger function)
- Inner data backup with an USB memory
- High legibility and setting convenient by graph LCD
- 25ms high sampling, 240mm/h high speed record function
- 100mm paper record (Selectable 6 kinds of record color)
- Supports system memory and external memory data backup (storage)
- Supports several input up to 12 channel with slot type input card
- Enables to select several option card with slot type output card
- Supports several communication(RS485, Ethernet) to transfer real time data
- Enables to set parameter with USB Device※1
- Space saving for installation with compact design (Rear length: 168mm)
- Supports total 27 kinds of input sensor
- Enables to order several type input card (weight, voltage, current, frequency, potential meter, etc)

1.2 Component and sold separately

1.2.1 Component

- Product
- Instruction manual
- Recording paper
- USB memory
- Bracket × 2
- Ink cartridge
- Basic connector × 2

(the number of additional connectors depends of the input/output card.)



Note

Before using KRN100, check the component.
If any component is left out or damaged, contact our company or seller.

1.2.2 Accessory

(1) I/O card

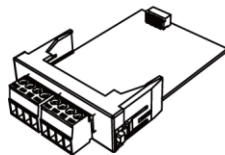

Digital input card
KRN-DI6

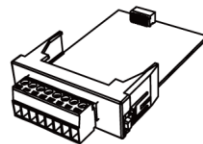

Alarm output card
KRN-AT6

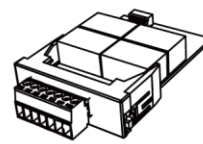

Alarm output card
KRN-AR4

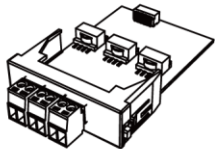



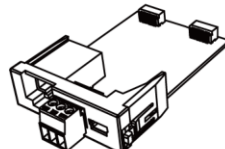

Transmitter power
output card KRN-24V3



Communication output
card KRN-COM

(2) Communication converter

SCM-38I (RS232C/RS485 converter)	SCM-US48I (USB/RS485 converter)
 	 

Appearances of SCM-38I (RS232C to RS485 converter) and SCM-US48I (USB to RS485 converter) are same.

1.3 Ordering information

(1) Ordering information

KRN100	-	12	0	0	0	-	0	0	-	0	S
①		②	③	④	⑤		⑥	⑦		⑧	⑨

	Description	
① Item	KRN100	New 100mm Paper Type Recorder
② Input channel	02	2-channel (KRN-UI2×1EA)
	04	4-channel (KRN-UI2×2EA)
	06	6-channel (KRN-UI2×3EA)
	08	8-channel (KRN-UI2×4EA)
	10	10-channel (KRN-UI2×5EA)
	12	12-channel (KRN-UI2×6EA)
③ Digital input	0	None
	1	6EA(KRN-DI6×1EA)
	2	12EA (KRN-DI6×2 EA)
④ Alarm transistor output	0	None
	1	6EA (KRN-AT6×1EA)
	2	12EA (KRN-AT6×2EA)
⑤ Alarm Relay output	0	None
	1	4EA (KRN-AR4×1EA)
	2	8EA (KRN-AR4×2EA)
	3	12EA (KRN-AR4×3EA)
⑥ Transmitter power output	0	None
	1	3EA (KRN-24V3×1EA)
	2	6EA (KRN-24V3×2EA)
	3	9EA (KRN-24V3×3EA)
	4	12EA (KRN-24V3×4EA)
⑦ Communication output	0	None
	1	RS485/Ethernet/USB (KRN-COM×1EA)
⑧ Power voltage	0	100-240VAC, 50/60Hz
⑨ Case	S	Standard panel mounting type

(2) I/O card model name

Type	Model name	Function and number of channel	Max. connectable card	Slot number
Universal input card	KRN-UI2	Universal input 2 channel	6EA	1 to 6
Digital input card	KRN-DI6	Digital input 6 channel	2EA	7 to 10 ^{※1}
Alarm output card	KRN-AR4	Alarm relay output 4 channel	3EA	
	KRN-AT6	Alarm transistor output 6 channel	2EA	
Transmitter power output card	KRN-24V3	Transmitter 24VDC power output 3 channel	4EA	
Communication output card	KRN-COM	RS485+USB+Ethernet communication channel	1EA	C

※1. Digital input card, alarm output card, transmitter power output card are connectable up to 4EA as mixed.

(3) Example of ordering

To use universal input 10-channel, digital input 4-channel, alarm relay output 5-channel, and RS485 communication output, it is ordered as KRN100-10102-01-0S and connected I/O card is as below.

- KRN100(Recorder): 1EA
- KRN-UI2(Universal input card): 5EA
(universal input card 1EA is 2-channel and 5EA×2-channel =10-channel)
- KRN-DI6(Digital input card): 1EA
- KRN-AR4(Alarm output card): 2EA
- KRN-COM(Communication output card): 1EA

1.4 Part description

1.4.1 Front and side part

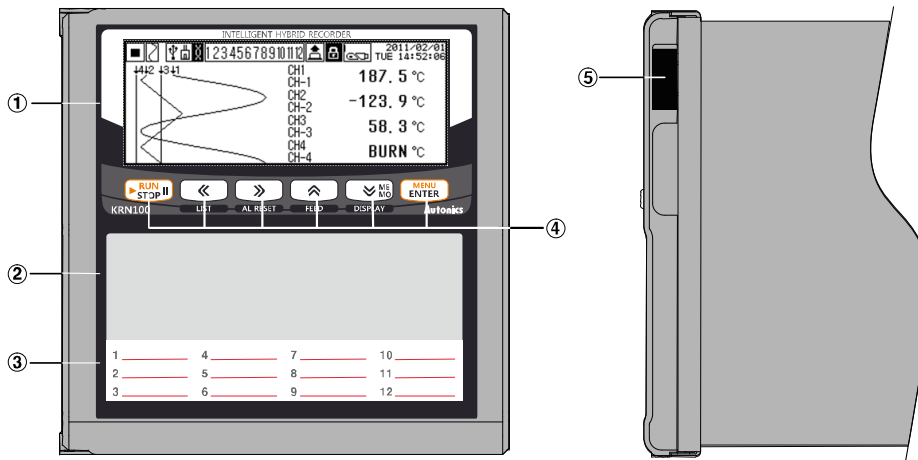







- ① Display part: Displays measurement values as trend graph, bar graph, or digital number (1/8/12 channel). Please refer to '7.1 Screen display'.
- ② Recording print part: Records measuring value of data by each channel with designated color.
- ③ Channel information part: Write the information by each channel.
- ④ Control key/Function key: Executes parameter setting and recording, and special function

Key	Function
	Using this key for starting/stopping recording, changing input characters on virtual keyboard status, and displaying Function key. Press this key for 3 sec in stop state, ink cartridge moves to the center. (Use this to replace ink cartridge.)
	Using this key for going out from parameter setting group or setting manual channel switch mode. It also executes to release auto channel switch mode and printer list output (3 sec) function.
	Using this key for moving parameter in setting mode, setting manual channel switch mode and forced alarm reset (3 sec).
	Using this key for moving parameter in setting mode, increasing digit value, setting auto channel switch mode, and manual feed function (by pressing over 3 sec.) in stop state.
	Using this key for moving parameter in setting mode, decreasing digit value, changing display mode and executing manual digital memo (3 sec) in recording state.
	Using this key for entering setting mode (3 sec) and set value change mode.

- ⑤ USB Host: Connects an USB memory. It recognizes max. 32Gbyte and if using cable, it is available up to 1.5m.

 Note

Function key: Use this key to enter virtual keyboard in parameter setting.

Press  key, and Function key appears on lower screen as below figure. Press , , , , or  key as below Function key, it operates the appropriate Function key's operation.

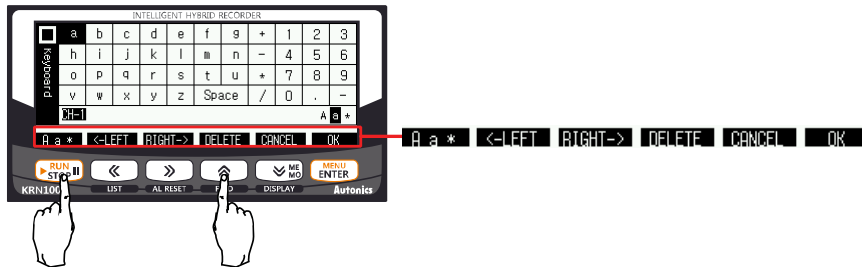

1.4.2 Back side

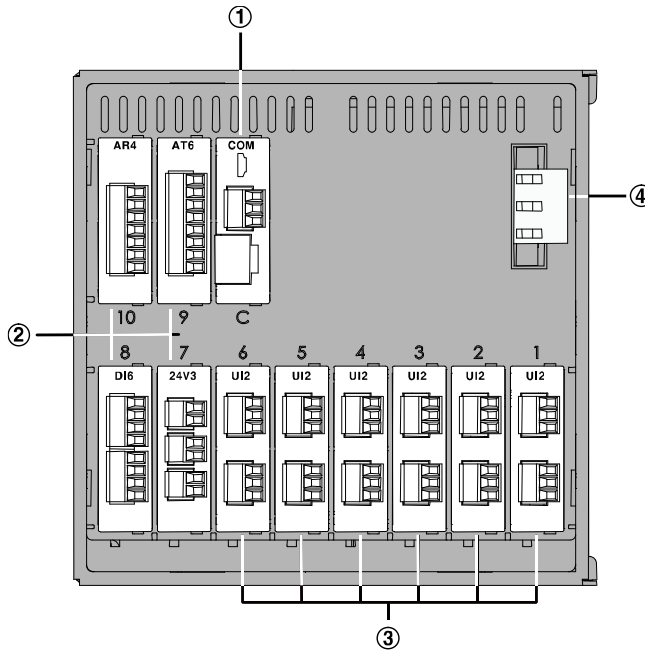

- ① Slot(C) for connecting communication output card(KRN-COM)
- ② Slot(7to10) for connecting digital input card(KRN-DI6), alarm relay output card(KRN-AR4), alarm transistor output card (KRN-AT6), transmitter power output card(KRN-24V3)
You can connect total 4EA by combining digital input card, alarm output card, and transmitter power output card, as below combination example.

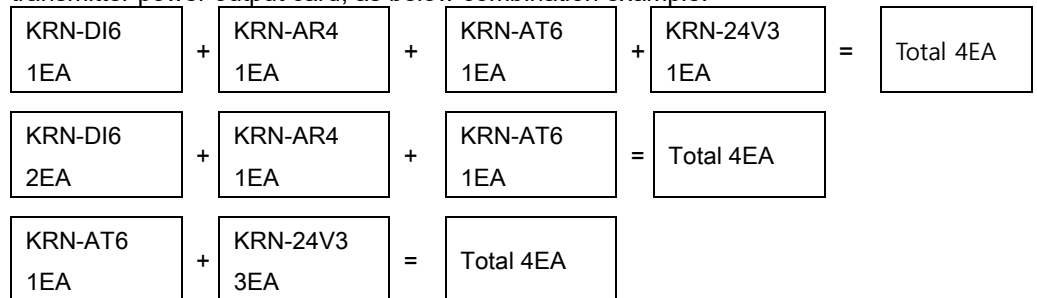

- ③ Slot(1 to 6) for connecting universal input card(KRN-UI2)
- ④ Power connecting part (100-240VAC, 50/60Hz)

※ Above back side image is connected every output card to help your understand.

1.4.3 Inside

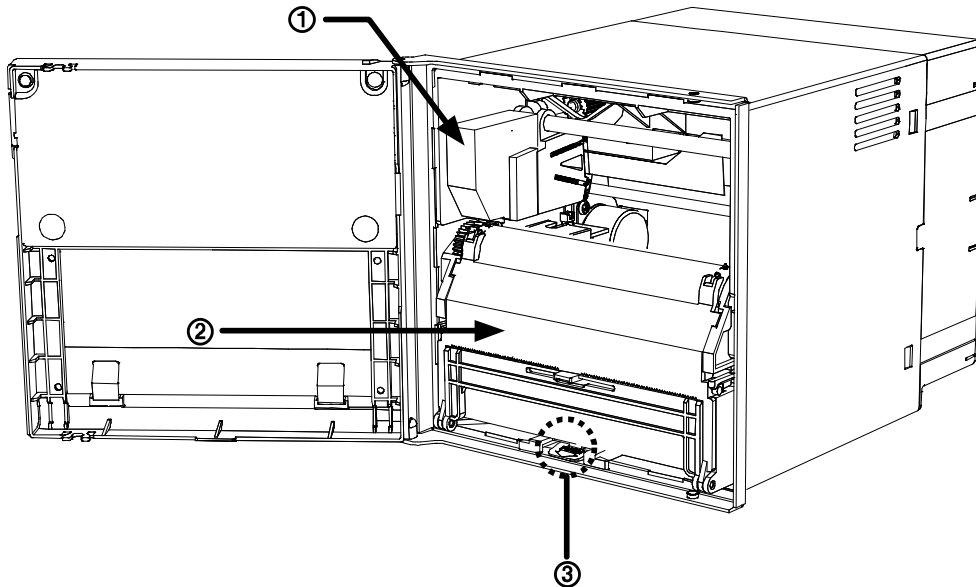

- ① Ink cartridge: Record ink cartridge to record data on recording paper.
(Model name: D33006B-66X-01)
- ② Recording paper cassette: Cassette saves the recording paper.
- ③ Recording paper cassette lever: Press the lever down and this recording paper cassette is removed from KRN100.
Remove the recording paper cassette for recording paper replacement, ink cartridge replacement.

1.4.4 Paper cassette

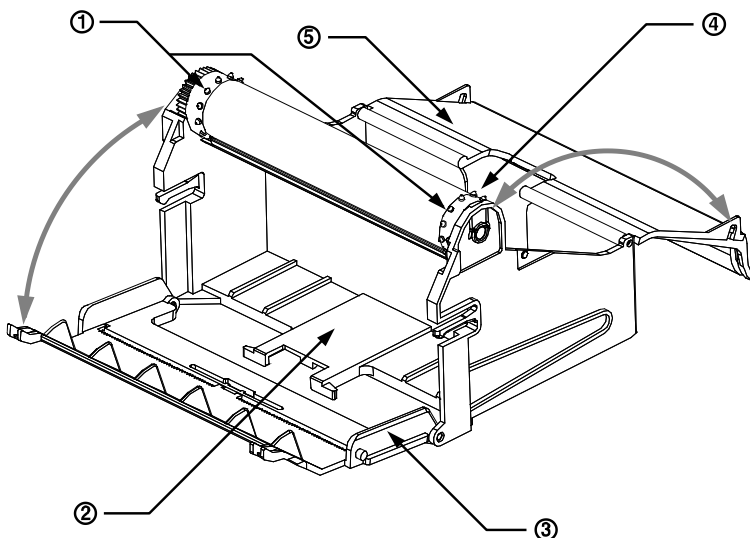

- ① Recording paper holder: Movement holder of recording paper when recording
- ② Recording paper storage part: Storage part for recorded recording paper
- ③ Front cover of recording paper storage: Open recording paper guide for recording paper replacement
- ④ New recording paper storage: Storage part for new recording paper (1EA recording paper is storable.)
- ⑤ Back cover of recording paper storage

2 Specification

2.1 KRN100

Model	KRN100	
Power voltage	100-240VAC~, 50/60Hz	
Allowable voltage range	85 to 110% of rated voltage	
Power consumption	Max. 55VA	
Screen	LCD type	STN Graphic LCD
	Resolution	320×120Pixel
	Adjusting brightness	4 level (OFF / Min / Standard / Max)
	Backlight	White LED, 2 level (Temp/Always)
The number of input channel	2 / 4 / 6 / 8 / 10 / 12 channel (2 channel/card)	
Universal input ^{*1}	Temperature sensor (RTD, thermocouple), analog (voltage, current)	
Sampling period	1 to 4-channel: 25ms/125ms/250ms, 5 to 12-channel: 125ms/250ms (Inner sampling cycle is operation unit time for average movement filter and alarm output function.) ※Min. sampling cycle for TC-R, U, S, and T sensor is 50ms.	
Recording period in graph mode	10, 20, 40, 60, 120, 240mm/h	
Recording accuracy	±0.5% F.S.	
Storage period	1 to 3,600 sec (storage interval time to inner log file is 1 sec)	
Inner memory	512MB	
USB memory ^{*2}	Recognizes max. 32GB, enables to use cable up to 1.5m	
Function	Record color, Record zone, Input special function, Input digital filter, Reservation set, Summer time, Delay alarm, Record speed change, Data storage, Backup data record, etc	
Dielectric	2,500VAC 50/60Hz for 1 min (power terminal and case) ※USB Device and Ethernet are excepted	
Vibration strength (for convey and storage) and operating vibration	Vibration strength: 10 to 60Hz 4.9m/s ² (in X, Y, Z axes for each 1 time) Operating vibration: 10 to 60 1m/s ² (in X, Y, Z axes for each 10 min)	
Insulated resistance	Over 20MΩ (at 500VDC megger)	
Noise	±2kV the square wave noise (pulse width 1μs) by the noise simulator	
Time accuracy	Within ±2min/year (enables to use up to 2100 year)	

Mechanism	Ink cartridge	Enables to normal print with going and returning printing max.5 times within 7 days after opening the unit
	Ink dry time	Max. 15 minutes
Protection		IP40 (front panel, IEC Standard)
Recording paper		113mm×9m
Installation environment		It shall be used indoor, Altitude Max. 2,000m, Pollution Degree2 Installation category II
Environment	Temperature	0 to 50 °C, storage: -20 to 60 °C, (without ink cartridge)
	Humidity	35 to 85% RH, storage: 35 to 85% RH ※If using this unit at place with high humidity, it may cause paper jam. Please do not use this unit at place with high humidity.
Approval		CE ENEC EAC
Weight ^{*3}		Approx. 2.4 to 2.7kg (approx. 1.7 to 2.0kg)

※1. For more information of universal input, please refer to '2.2 I/O card'.

※2. USB memory is included in the box. If you use USB memory you purchased separately, it could not be recognized.

※3. Environment resistance is rated at no freezing or condensation.

※4. The weight includes packaging. The weight in parenthesis is for unit only.

2.2 I/O card

Type	Model	I/O specification		Description
Universal input card	KRN-UI2	Input specification ^{※1}	RTD	JPt100Ω, DPt100Ω, DPt50Ω, Cu100Ω, Cu50Ω (supply current 420μA)
			Thermocouple	B, C(W5), E, G, J, K, L, L(Russia), N, P, R, S, T, U
			Analog	Voltage: ±60mV ±200mV ±2V, 1-5V, ±5V, -1V-10V Current: 0.00-20.00mA 4.00-20.00mA
		Input impedance		Voltage(V): min. 150kΩ RTD, thermocouple, voltage(mV): min. 2MΩ Current: 51Ω
		Display accuracy ^{※2}	RTD	Warm-up time: Min. 30 minutes ·Room temperature (25°C±5°C) section : ±0.1% F.S.±1 digit ·Out of range of room temperature: ±0.2% F.S.±1 digit RTD: 500 to 850°C is PV value±0.5%±1 digit Thermocouple: below -100°C is ±0.3% F.S. ±1 digit
			Analog	
Resolution		16Bit		
Digital input card	KRN-DI6	Noncontact input		ON: max. 1VDC≡ of residual voltage, OFF: max. 0.1mA leakage current
		Contact input		ON: max. 1kΩ, OFF: min. 100kΩ, Outflow current for short: approx. 4mA
Alarm output card	KRN-AR4	Alarm relay output	Capacity	250VAC~ 3A, 30VDC≡ 3A, 1 Form A (resistance load)
			Life	Mechanical: min. 50,000,000 operations Electrical: min. 100,000 operations (3A 250VAC~, 3A 30VDC≡)
	KRN-AT6	Alarm transistor output		NPN Open Collector, 12-24VDC / 30mA Max.
Transmitter power output card	KRN-24V3	Power output for transmitter		24±2VDC≡, total 3 channel, max. 30mA per 1 channel built-in over-current protection circuit
Communication output card ^{※3}	KRN-COM	Communication output	RS485	Modbus RTU ※Recommended to use shield cable over AWG24 EEPROM life cycle: ≈ 1,000,000 operations (Erase / Write)
			Ethernet	IEEE802.3(U), 10/100 BASE-T(Modbus TCP)
			USB Device ^{※4}	USB V2.0 Full Speed(Device Control)

- ※1. To change input specification, you must turn OFF the power of KRN100, remove universal input card, set inner jumper pin (Please refer to 4.2 I/O card.) and re-connect it.
- ※2. Exception range for better accuracy by sensor (Accuracy after 30min warm-up time)
 - R,S,C,G: $0 \leq T \leq 100 \pm 4.0^\circ\text{C}$
 - B: No regulation accuracy below 400°C
 - T, U: $-200 \leq T \leq -100 \pm 3.0^\circ\text{C}$, $-100 \leq T \leq 400 \pm 2.0^\circ\text{C}$
 - ◎Room temperature($23^\circ\text{C} \pm 5^\circ\text{C}$)
 - Cu50Ω: $-200 \leq T \leq 200 \pm 1.0^\circ\text{C}$, DPt50Ω: $-200 \leq T \leq 500 \pm 1.5^\circ\text{C}$
 - ◎Out of range of room temperature
 - Cu50Ω: $-200 \leq T \leq 200 \pm 2.0^\circ\text{C}$, DPt50Ω: $-200 \leq T \leq 500 \pm 3.0^\circ\text{C}$
- ※3. RS485, Ethernet communication output are not available at the same time.
- ※4. The front USB Device only for data backup and rear USB device is available only for parameter setting.
- ※ It is recommended to use shield cable to decrease noise when sensor input cable is longer.

**Caution**

If connecting or disconnecting input/output card when power is ON, it may cause malfunction.
To connect or disconnect input/output card, you must turn OFF the power.

2.3 Input specification and measuring range

Input sensor		Mark	Measuring range		
			°C	°F	K
Thermocouple	K(CA)	TC-K	-200.0 to 1350.0	-328.0 to 2462.0	73.2 to 1623.2
	J(IC)	TC-J	-200.0 to 800.0	-328.0 to 1472.0	73.2 to 1073.2
	E(CR)	TC-E	-200.0 to 800.0	-328.0 to 1472.0	73.2 to 1073.2
	T(CC)	TC-T	-200.0 to 400.0	-328.0 to 752.0	73.2 to 673.2
	B(PR)	TC-B	100.0 to 1800.0	212.0 to 3272.0	373.2 to 2073.2
	R(PR)	TC-R	0.0 to 1750.0	32.0 to 3182.0	273.2 to 2023.2
	S(PR)	TC-S	0.0 to 1750.0	32.0 to 3182.0	273.2 to 2023.2
	N(NN)	TC-N	-200.0 to 1300.0	-328.0 to 2372.0	73.2 to 1573.2
	C(TT) ※1	TC-C	0.0 to 2300.0	32.0 to 4172.0	273.2 to 2573.2
	G(TT) ※2	TC-G	0.0 to 2300.0	32.0 to 4172.0	273.2 to 2573.2
	L(IC)	TC-L	-200.0 to 900.0	-328.0 to 1652.0	73.2 to 1173.2
	L (Russian type)※3	TC-L_R	0.0 to 600.0	32.0 to 1112.0	273.2 to 873.2
	U(CC)	TC-U	-200.0 to 400.0	-328.0 to 752.0	73.2 to 673.2
	Platinel II	TC-P	0.0 to 1350.0	32.0 to 2462.0	273.2 to 1623.2
Resistance temperature detector (RTD)	Cu50Ω	CU50	-200.0 to 200.0	-328.0 to 392.0	73.2 to 473.2
	Cu100Ω	CU100	-200.0 to 200.0	-328.0 to 392.0	73.2 to 473.2
	JPt100Ω	JPT100	-200.0 to 600.0	-328.0 to 1112.0	73.2 to 873.2
	DPt50Ω	DPT50	-200.0 to 600.0	-328.0 to 1112.0	73.2 to 873.2
	DPt100Ω	DPT100	-200.0 to 850.0	-328.0 to 1562.0	73.2 to 1123.2
Analog	Voltage	-60.00-60.00mV	±60mV	Resolution:10μV	-99999 to 99999 (display range depends on the decimal point position)
		-200.00-200.00mV	±200mV	Resolution:10μV	
		-2.000-2.000V	±2V	Resolution: 1mV	
		1.000-5.000V	1-5V	Resolution: 1mV	
		-5.000-5.000V	±5V	Resolution: 1mV	
		-1.00-10.00V	-1V-10V	Resolution: 10mV	
	Current	0.00-20.00mA	0-20mA	Resolution:10μA	
		4.00-20.00mA	4-20mA	Resolution:10μA	

※1. C(TT): Same temperature sensor type as existing W5(TT).

※2. G(TT): Same temperature sensor type as existing W(TT).

※3. Russian type L type temperature sensor is divided from general purpose L type.



Note

When changing input type to voltage (over ±2V) or current, set the jumper pin of KRN-UI2 (universal input card). Its factory default is temperature sensor input. Refer to the '4.2 I/O card'.

3 Dimensions

(1) KRN100

(Unit: mm)

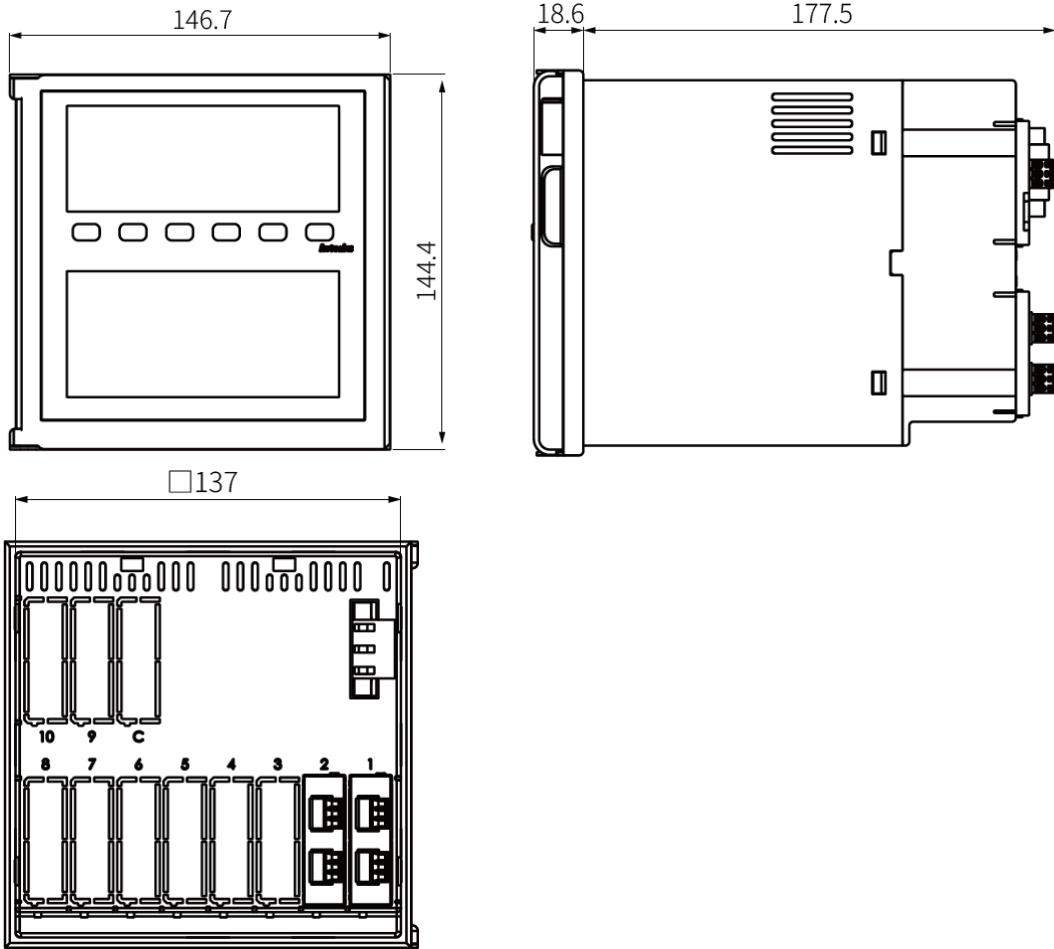

(2) Panel cut-out

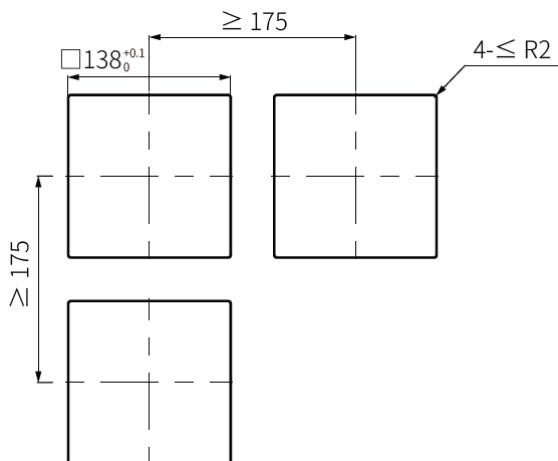

※ Use panel which is 2 to 8mm thickness.

(3) Bracket

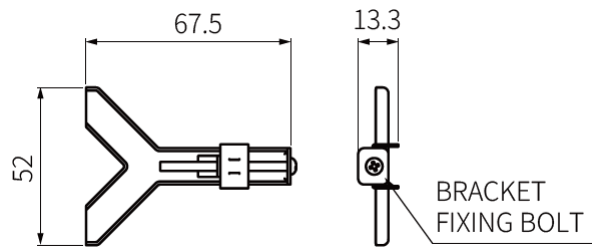

4 Connection

4.1 KRN100

This figure is back side of KRN100-04000-00-0S model.

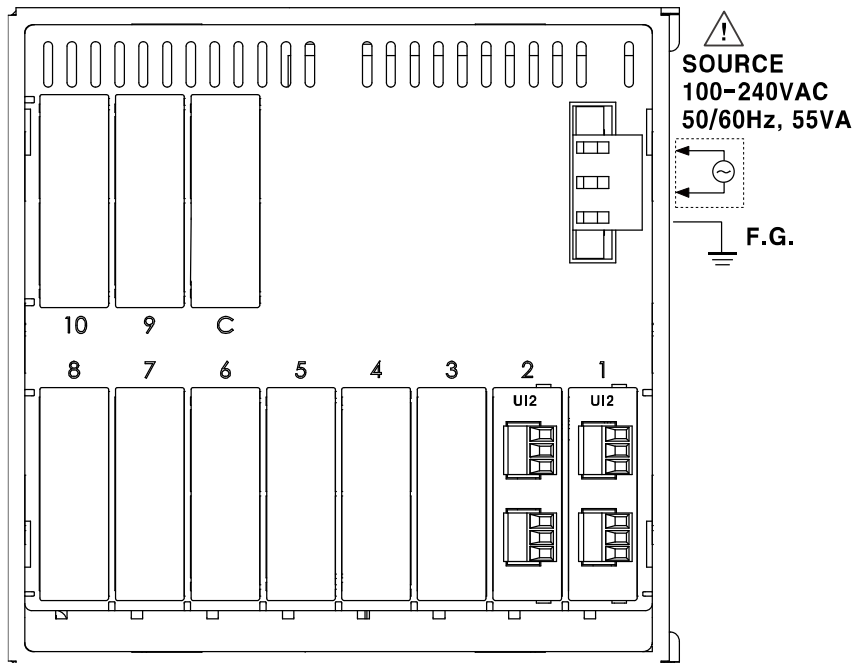

Slot	Description
1 to 6	Connects universal input card (KRN-UI2).
7 to 10	Connect digital input card (KRN-DI6), alarm output card (KRN-AR4, KRN-AT6), and transmitter power output card (KRN-24V3).
C	Connects communication output card (KRN-COM).

4.2 I/O card

Universal input card [KRN-UI2]	Digital input card [KRN-DI6]
<p>Each channel is isolated and dielectric strength is 500 V.</p>	
Alarm output card [KRN-AR4(relay output)]	Alarm output card [KRN-AT6(transistor output)]
<p>Alarm Output Relay Contact 250VAC 3A 1a RESISTIVE LOAD</p>	<p>Alarm Output NPN Open Collector 12-24VDC / 30mA Max. RESISTIVE LOAD</p> <p>※AL1,2,3 and AL4,5,6 are isolated.</p>
Transmitter power output card [KRN-24V3]	Communication output card [KRN-COM]
<p>※24V output of 3EA is isolated individually.</p>	

 **Note**

Before setting the parameters, set the jumper pin channel 1/2 of universal input card (KRN-UI2) depending on input specification as below figure.

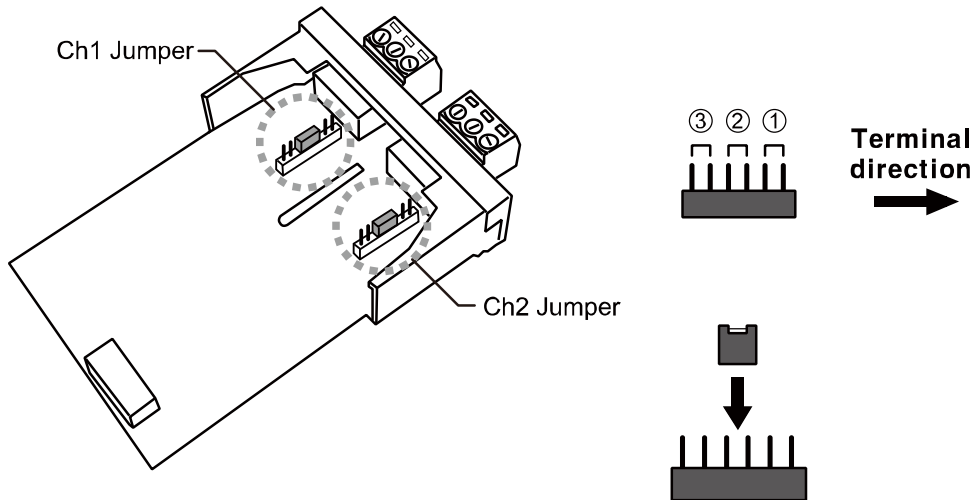

Jumper pin	Input specification	Input break alarm
①	0 to 20mA, 4 to 20mA	Enables only 4 to 20mA
②	TC, RTD, $\pm 60\text{mV}$, $\pm 200\text{mV}$	Enables
③	$\pm 2\text{V}$, 1 to 5V, $\pm 5\text{V}$, -1 to 10V	Disables

5 Installation

5.1 Installation place

Install this unit in place where the below conditions are satisfied.

- Place where ventilation is well
To prevent from malfunction and damage by overheating (use temperature range: 0 to 50°C), install this unit where ventilation is well.
In case installing several KRN100, space each other by panel cut-out.
- Place where vibration is not severe
If there is too much vibration, it may cause malfunction such as print error.
For more information about vibration, please refer to '2 Specification'.
- In case of temperature measurement with thermocouple temperature sensor at the place where temperature is fluctuated, data error may occur. You should warm-up this unit over 30 min. to acquire accurate data before using it.
- At the place where temperature and humidity is fluctuated excessively, recording paper color may be changed.

5.2 Installation

5.2.1 Bracket mounting

Install KRN100 on the processed panel as panel cut-out diagram. Mount fixing brackets on upper/lower parts.

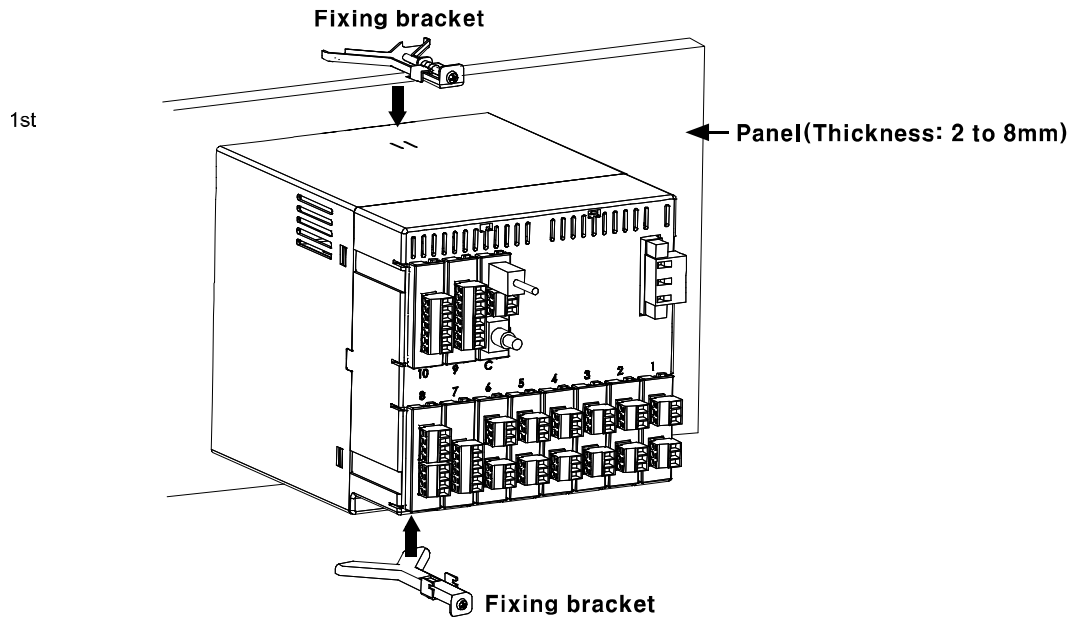

2nd

Tighten fixing brackets on upper/lower parts to fix on the panel with phillips screwdriver (+). (Torque: 0.4N•m)

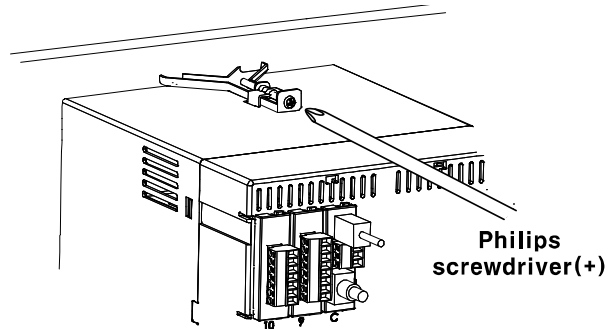

5.2.2 Additional I/O card connection

To connect I/O card additionally, turn OFF the power of KRN100.

Remove the proper slot cover with flat-head screwdriver or knife.

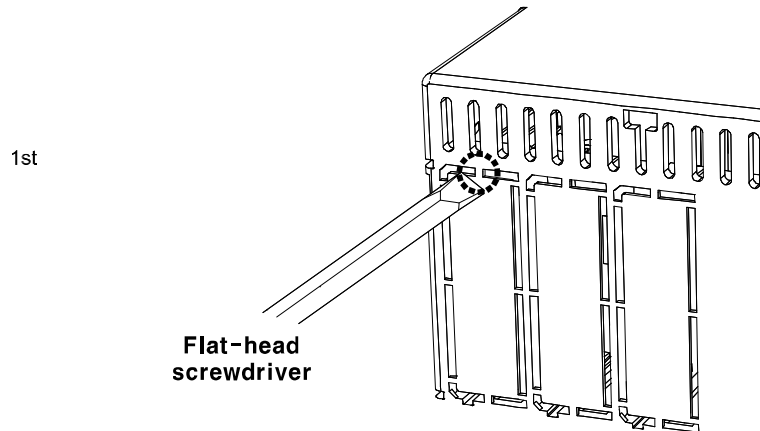

Insert I/O card to the proper slot and turn ON the power of KRN100.

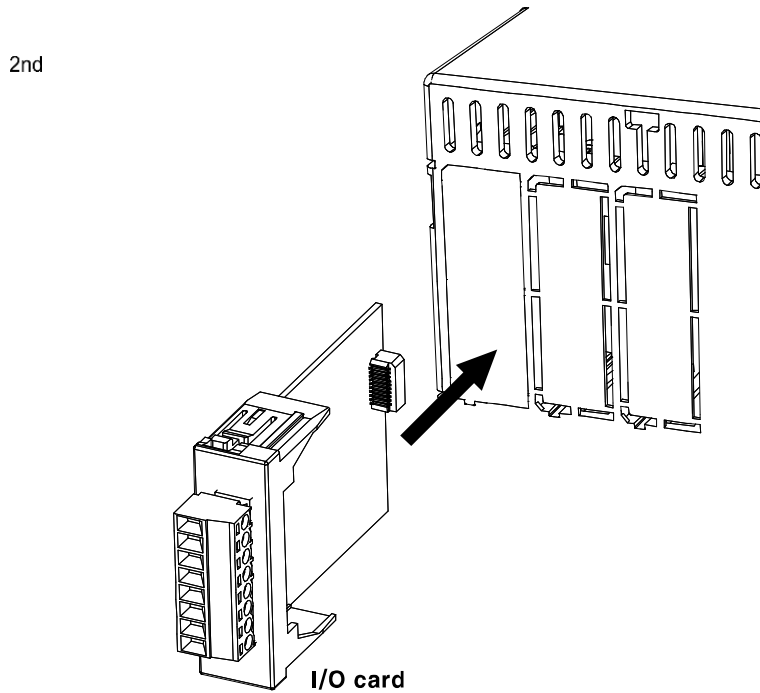

5.3 USB to Serial driver

Install USB to serial driver which is applied for KRN100 series and connect DAQMaster and you can set parameter setting. (It is available only when communication output card (KRN-COM) is connected. Supporting operation system for USB to Serial driver is Windows XP, VISTA(32/64bit), 7 (32/64bit).)

5.3.1 Driver installation

Visit our homepage www.autonics.com and download 'KRN100_USB_Serial_Drivers'.

Unzip this file to the desired folder.

Connect KRN100 USB port of communication output card(KRN-COM) and PC USB port with USB cable (A-Mini 5P, 1.5m).

1st

2nd

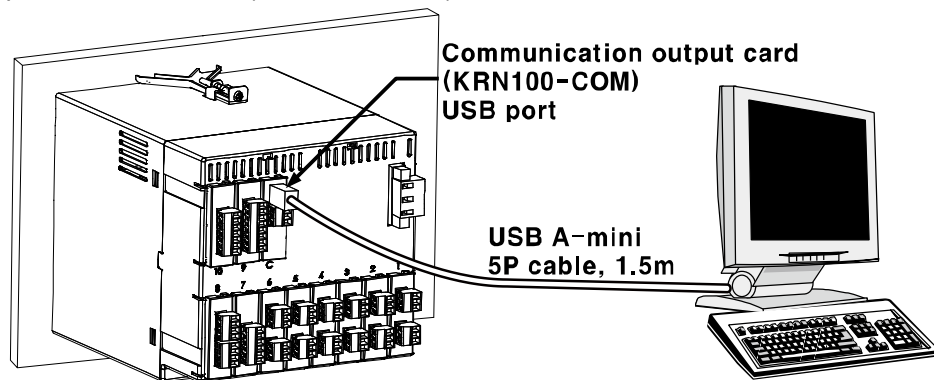

3rd

'Found New Hardware Wizard' appears.

Select 'Install from a list or specific location (Advanced)' and click 'Next>'.



Select 'Search for the best driver in these locations' and check 'Include this location in the search:'.

Click 'Browse' and select the folder which has 'KRN100_USB_Serial_Drivers' and click 'OK'.

4th

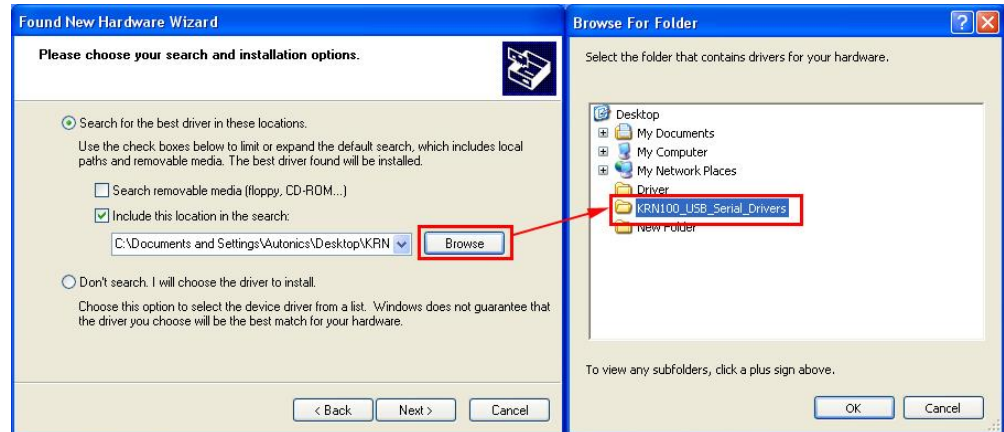

If hardware compatibility message appears, click 'Continue Anyway' and it processes the next.

5th



6th

At 'Completing the Found New Hardware Wizard', click 'Finish' and driver installation is complete.



5.3.2 Checking driver

To check the driver, right click 'My computer' and select 'Properties' on pop-up menu. 'System Properties' dialog appears.

Select 'Hardware' tab and click 'Device Manager'. 'Device Manager' dialog appears.

Check 'Ports(COM & LPT)' - 'KRN100 USB To Serial Converter (COMx)'.

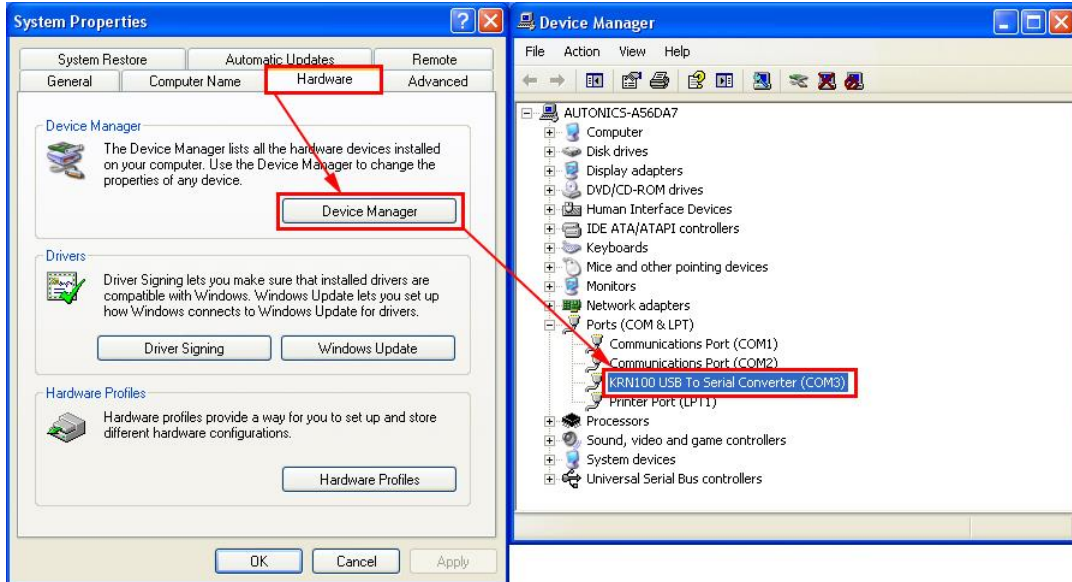

6 Display

6.1 Initial booting screen

Below booting screens are initially displayed when power is supplied to KRN100. These screens progress initial settings for KRN100 to operate normally and check inner system memory.

If there is no error for inner system memory, booting is finished and KRN100 operates normally.

- Screen for progressing initial setting



- Screen for checking error of inner system memory

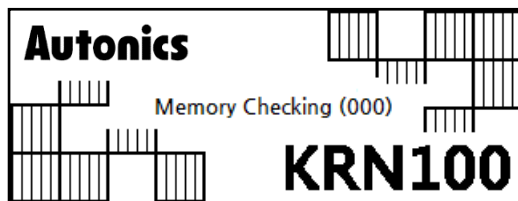

If there are lots of log data files, booting time may take a long time.

Delete log data file. For more information, refer to '8.8.4 Memory Clear (Delete memory)'.

- Screen for error of inner system memory

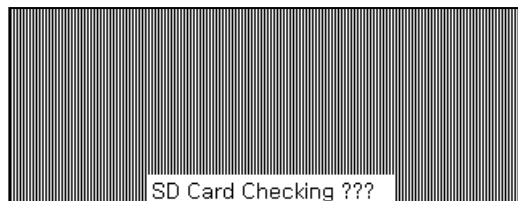

Above this figure, if there is error of inner system memory, KRN100 cannot operate normally.

Please contact us. Autonics service center: +82-32-820-2356~7

6.2 Screen layout

Screen layout is divided as two; upper screen for status display, lower screen for measuring value display, virtual keyboard display, parameter setting display.

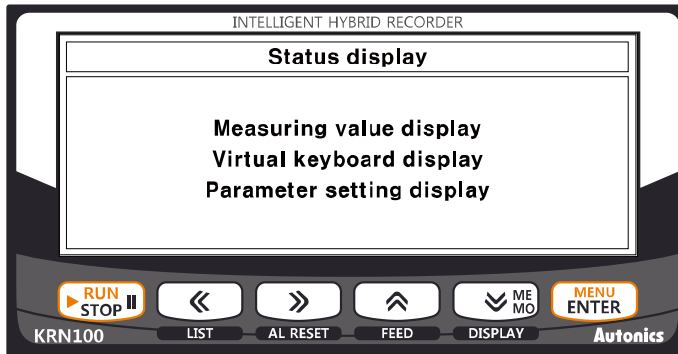





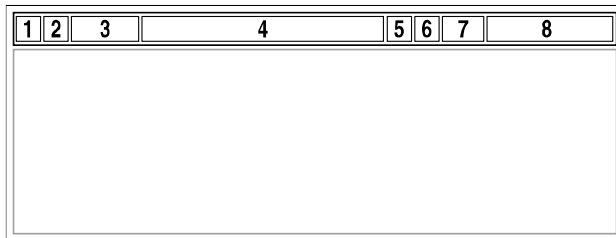









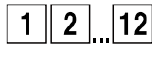







6.2.1 Status display

Upper screen displays recorder status and information of recorder as icon.

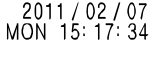

Section	Icon	Name	Description
1		Record start icon	Marks if for starting recording measuring value of recordable channels.
		Record stop icon	Stops recording measuring value.
		List record icon	Flashes during list recording.
		Reservation record icon	Flashes during reservation recording.
		FEED icon	Flashes during feeding recording paper.
		Backup data print icon	Flashes during backup data printing.
2		Digital mode icon	Marks it for digital record mode.
		Graph mode icon	Marks it for graph record mode.
		Record memory status icon	Marks it storage capacity of record memory in digital mode or graph mode.
		No recording paper icon ^{*1}	Marks it for no recording paper. Please replace new recording paper.

Section	Icon	Name	Description
3		USB communication icon	Marks  icon during Modbus RTU communication using USB.
		Ethernet communication icon	Marks  icon during Modbus TCP communication using Ethernet.
		RS485 communication icon	Marks  icon during Modbus RTU communication using RS485.
4		Alarm ON icon	Marks  channel icon which alarm occurs.
5		Digital input(DI) icon	Marks the below icon according to input function setting during digital input (DI).
		Digital input(DI)- memo icon	Marks it when digital memo of digital input or front  is input in recording status.
		Digital input(DI)- alarm reset icon	Marks it when alarm reset signal of digital input (DI) is input.
		Digital input(DI)- start record icon	Marks it when start record signal of digital input (DI) is input.
		Digital input(DI)- stop record icon	Marks it when stop record signal of digital input (DI) is input.
		Digital input(DI)- LIST output icon	Marks it when LIST output signal of digital input (DI) is input.
		Digital input(DI)- record speed icon	Marks it when changing record speed signal of digital input (DI) is input.
6		Unlock icon	Marks it for unlock status.
		User(general user) lock icon	Marks it for user (general user) lock status.
		Administrator lock icon	Marks it for administrator and general user lock status.
7		Inner and external (USB) memory capacity icon	Displays data capacity of internal memory as bar graph. When an USB memory is connected, it displays data capacity of an USB memory as bar graph  . If used memory capacity is over 90% of total capacity, it flashes.
8		Date/Time display	Displays current date and time. In summer time season, (S) mark is also displayed at front of year.

※1. If there is no recording paper,  icon flashes. After replacing recording paper, P.END BACKUP PRINT screen as below is activated.

Backup data recording function by P.END is same as RECORD BACKUP. Backup Data List cannot be changed.

















Starting print by P.END Backup, it prints the data but backup data file date, file name, and backup record starting line.

6.2.2 Virtual keyboard

You can enter set value with virtual keyboard. (Supports only English letters for entering character.)

Virtual keyboard is activated when set value is input.

You can enter English letters, numbers, special characters by , , , , , and  keys.

No	Front key	Description
1		Press  key once and English capital letters, English small letters, and special character virtual keyboard is switching.※1 When pressing and holding  key, screen of Function key is displayed. ※2
2	 ,  ,  , 	Moves digit to select character of virtual keyboard
3		Enters set characters

※1. Enterable characters are as below.

- English capital letters



- English small letters



- Special character





※2. Screen of Function key using

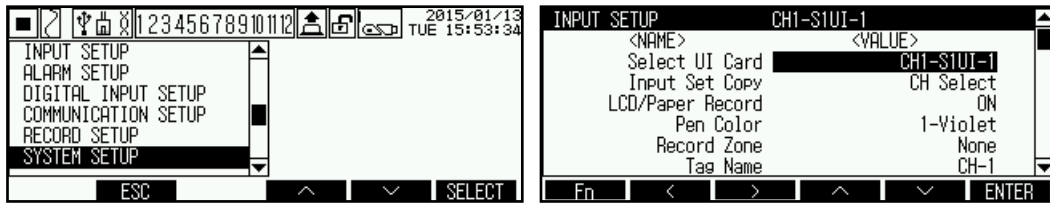

6.2.3 Parameter setting display



Press front  key for 3 sec, and it enters parameter setting group.

When entering parameter setting group, settable parameter setting groups are displayed. At parameter setting group, press  key to enter parameter setting.

For more information of parameter detail setup, please refer to '8 Parameter detail setup'.

7 Operation

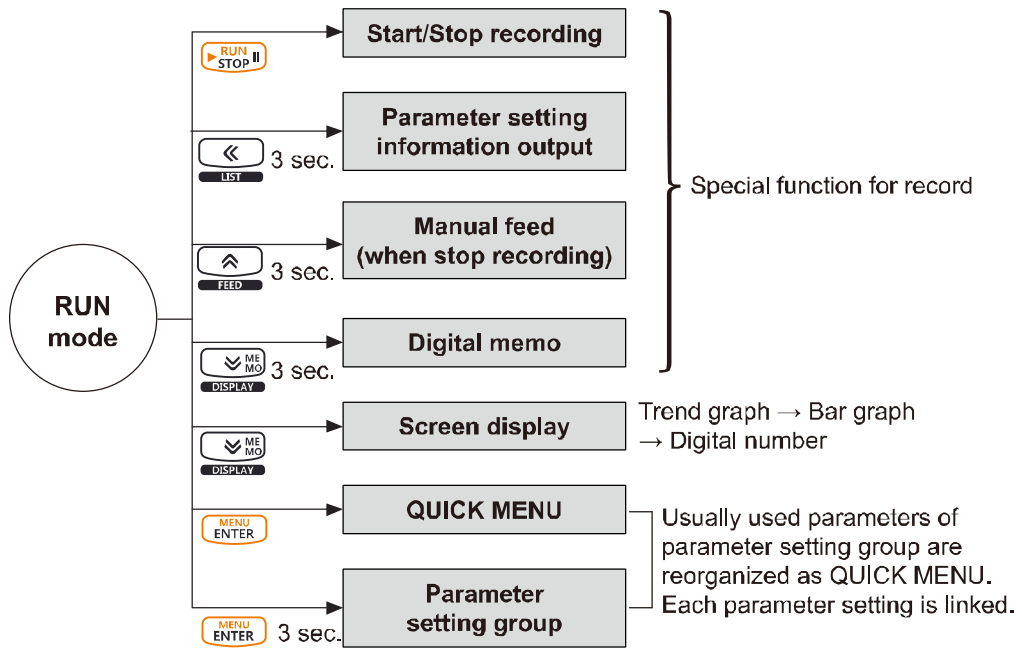

7.1 Screen display

7.1.1 Measuring value display

KRN100 displays measuring value as trend graph, bar graph, and digital number display(1 channel, 8 channels, 12 channels). You can select one by **ME MO DISPLAY** key.

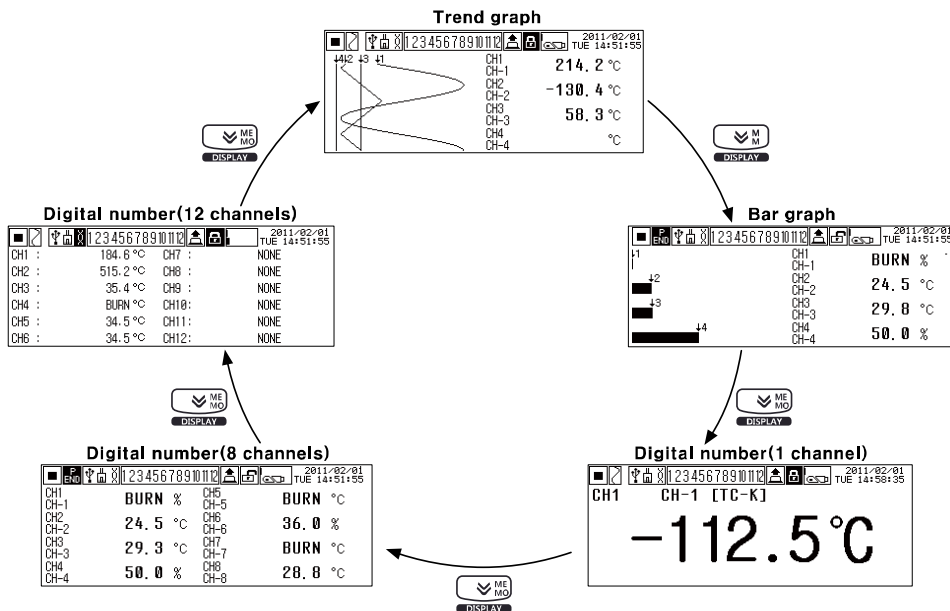

(1) Trend graph

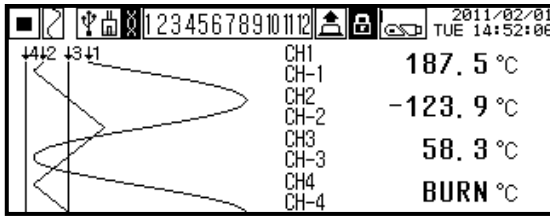

Displays input measuring value of each channel as trend graph (left) and digital number (right).

4 channels are displayed per one screen. To switch channel, please refer to “7.1.2 Channel switch”.

(2) Bar graph

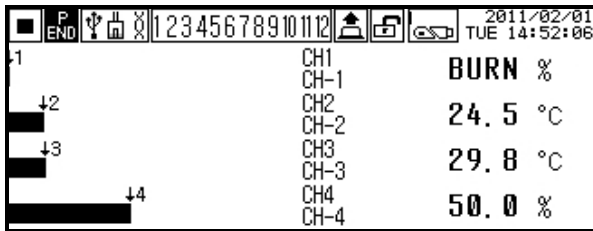

Displays input measuring value of each channel as bar graph (left) and digital number (right). You can easily check present measuring value within the set display range as level (%).

4 channels are displayed per one screen. To switch channel, please refer to “7.1.2 Channel switch”.

(3) Digital number

Displays input measuring value of each channel as digital number.

Digital number display is divided as 1 channel digital number, 8 channels digital number, 12 channels digital number.

- Display of 1 channel digital number: Displays 1 channel per 1 screen with big font size. It has high visibility.

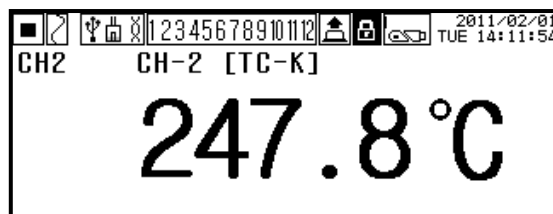

- Display of 8 channels digital number: Displays 8 channels per 1 screen.

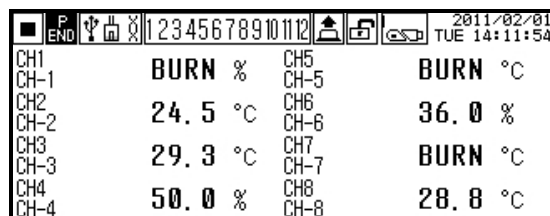

- Display of 12 channels digital number: Displays 12 channels (all channels) per 1 screen.

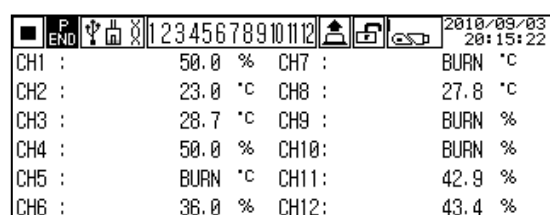

7.1.2 Channel switch

It displays measuring value of all input channels by switching channel of display types. You can set channel switch mode as auto channel switch or manual channel switch.

7.1.2.1 Auto channel switch

A screen displays 4 channels and automatically switches other screens by 3 sec period.

(1) Trend graph

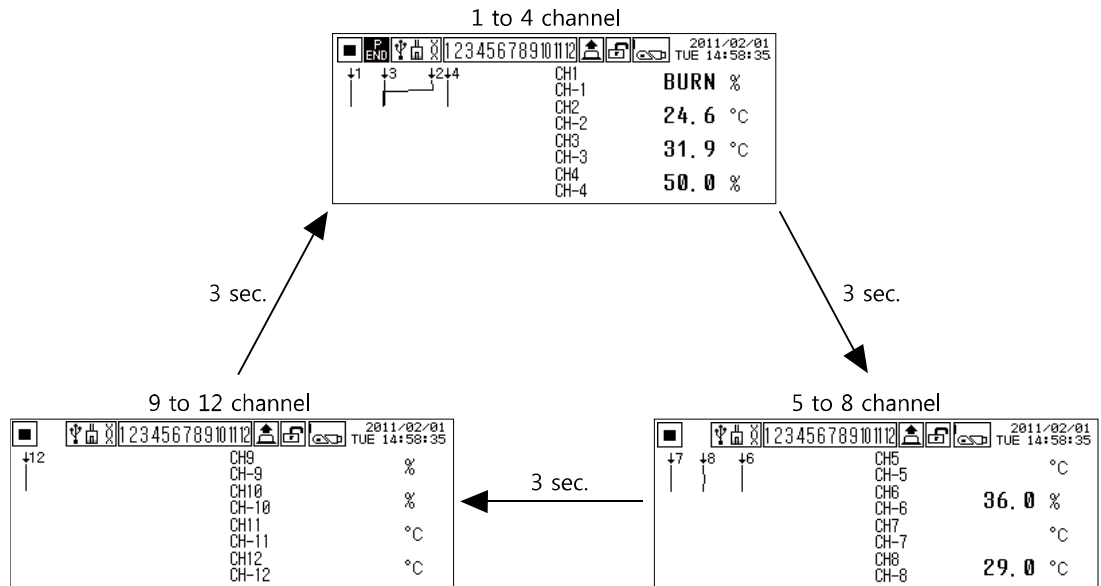

(2) Bar graph

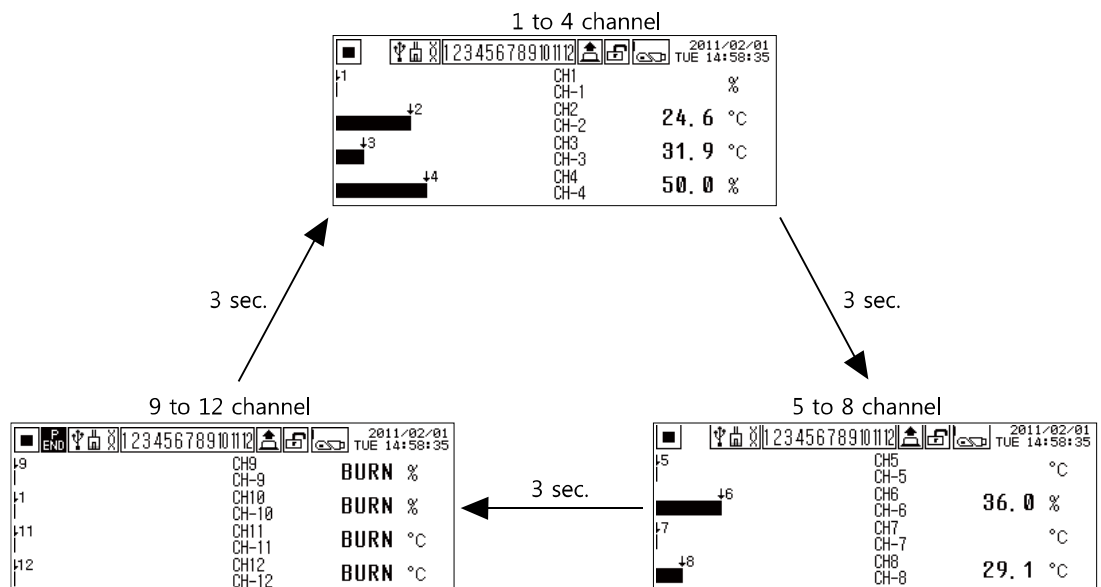

(3) Digital number(1 channel)

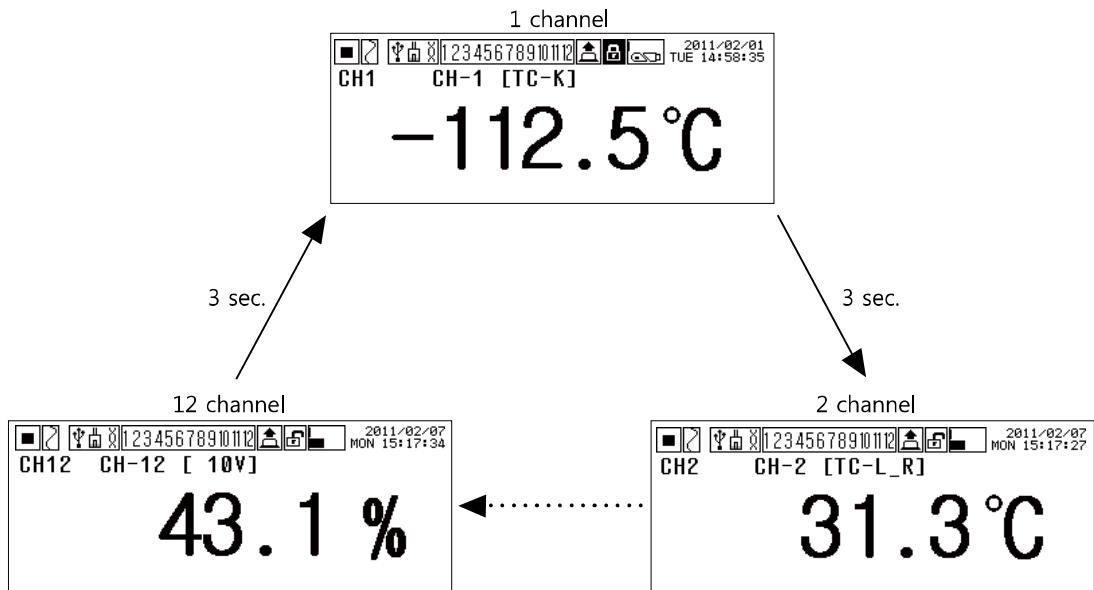

(4) Digital number(8 channels)

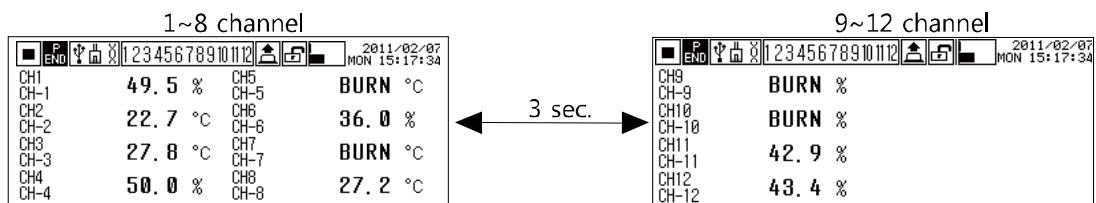

(5) Digital number(12 channels)

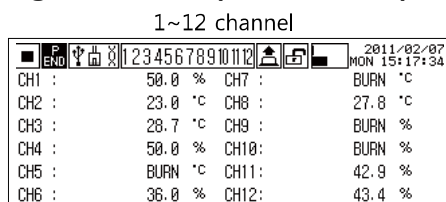

1st Digital number (12 channels) displays all channels (1 to 12 channel). It does not support auto/manual channel switch function.

7.1.2.2 Auto channel switch mode ↔ Manual channel switch mode

2nd
3rd When supplying/re-supplying power to KRN100, it is display currently display and auto channel switch mode.

4th If you want to change manual channel switch mode, press key or key. You can switch/select the to-be displayed channel by pressing key or key.



In manual channel switch mode, press key to change to auto channel switch mode.

7.2 Special operation for record

KRN100 executes special operation for record with front keys (, , , .

(1) Start record (RUN)/Stop record (STOP)

Press front  key at once, it starts recording and press this key once again, it stops recording.

When digital input operation status is set as 'Level', you cannot start/stop record by front  key. In case of as 'Edge', start record (RUN)/stop record (STOP) function is available with front  key.

(2) Parameter's set information print (List Print)

This function is to record the main parameter's set information on recording paper. Press  key for over 3 sec. during recording or stop state, and it records the set information of each menu.

For more information, please refer to '8.5.13 List Out Option (List record option)'.





Note

Even if you print the parameter set information with max record speed (240mm/h), it takes a lot of time. (It takes approx. 40 minutes for 12 channels.)



Be sure that for printing the list.

(3) Manual feed (FEED)

In record STOP state, press front  key for over 3 sec, record state icon is changed to  icon and you can feed recording paper manually.

To tear recording paper, use this manual feed function at first.

(4) Digital memo (Digital Memo)

Press  for over 3 sec, during recording status, digital input icon  changes to  memo icon. It records current time (hh:mm:ss) and display value of each channel as digital number on recording paper. It also displays 'M' which means the recording by memo at front of current time.

7.3 Parameter setting group

7.3.1 Parameter setting

The setting order of KRN100 basic parameters is as below.

For more information of detail setup of each parameter, please refer to '8 Parameter detail setup'.

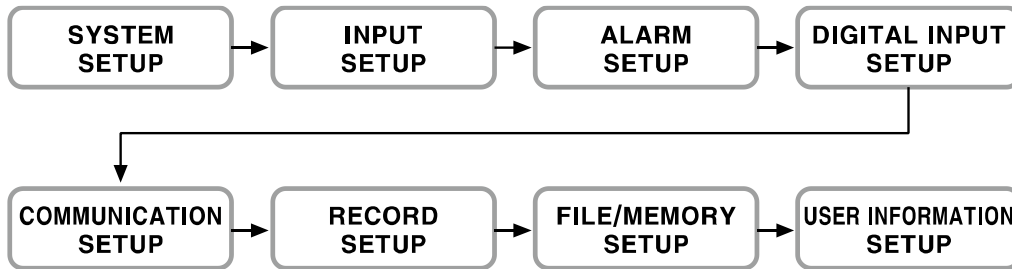

- To enter parameter setting group: Press key for 3 sec.
- To move among setting group: ,
- To move the setting:
- To move upper parameter after setting: Press key and Function key is activated which is placed at bottom right as below figure. Press OK () key or Cancel () key.
 - Cancel: Moves to upper parameter after not saving the setting.
 - OK: Moves to upper parameter after saving the setting.

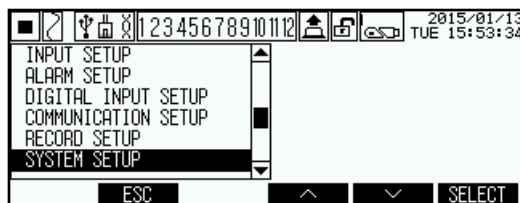

7.3.2 QUICK MENU

QUICK MENU [1]					
CH	TYPE	DOT	UNIT	PEN COLOR	▶▶▶
CH-1	TC-K	0.0	'C	Violet	
SET	SET	SET	SET	SET	NEXT

QUICK MENU consists of usually used parameters for quickly parameter setting.

7.3.2.1 Parameters of QUICK MENU

Page	Parameter	Description	Linked parameters
QUICK MENU [1]	CH	Select channel for the QUICK MENU[1] setting.	
	TYPE	Input type	[INPUT SETUP]-[Input Type]
	DOT	Decimal point	[INPUT SETUP]-[Range/Scale Point]
	UNIT	Display/Temperature unit	[INPUT SETUP]-[Display/Temp Unit]
	PEN COLOR	Pen color	[INPUT SETUP]-[Pen Color]
QUICK MENU [2]	CH	Select channel for the QUICK MENU[2].	
	LOW RANGE	Low-limit input value or graph scale value	[INPUT SETUP]-[Low Range] or [INPUT SETUP]-[Low Graph Scale]
	HIGH RANGE	High-limit input value or graph scale value	[INPUT SETUP]-[High Range] or [INPUT SETUP]-[High Graph Scale]
	LOW SCALE	Low-limit scale value	[INPUT SETUP]-[Low Scale]
	HIGH SCALE	High-limit scale value	[INPUT SETUP]-[High Scale]
QUICK MENU [3]	PRINT MODE	Record mode	[RECORD SETUP]-[Record Mode]
	PRINT SPEED	Standard record speed	[RECORD SETUP]-[Standard Speed]
	PRINT MEMO	Digital memo period	[RECORD SETUP]-[Memo Period]
	BACK LIGHT	LCD backlight	[SYSTEM SETUP]-[Backlight]
	LCD ON/OFF	LCD backlight On/Off	[SYSTEM SETUP]-[Backlight On/Off]
QUICK MENU [4]	USB REC	Memory save	[FILE/MEMORY SETUP]-[USB LogData Save]
	USB COPY	Call USB COPY window	[FILE/MEMORY SETUP]-[USB Memory Copy/Move]
	UPGRADE	Call upgrade window	[USER/INFORMATION SETUP]-[Firmware Upgrade]
	CANCEL	Cancel the settings	
	SAVE	Save the setting of QUICK MENU[1] to [4].	

7.3.2.2 QUICK MENU Setting

Press the **MENU ENTER** key once in RUN mode and it enters to QUICK MENU.

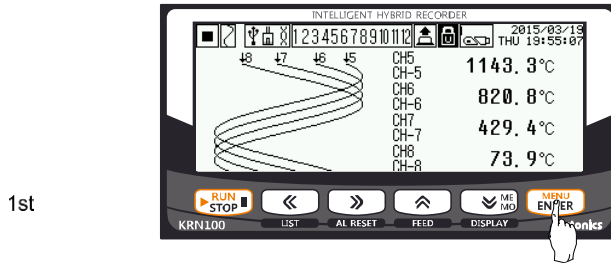

Set the keys following the each parameter. Press the NEXT (**MENU ENTER**) key and it moves to next page.

E.g.) When changing the temperature unit ($^{\circ}\text{C} \rightarrow ^{\circ}\text{F}$) of CH1, press the SET (**FEED**) key.

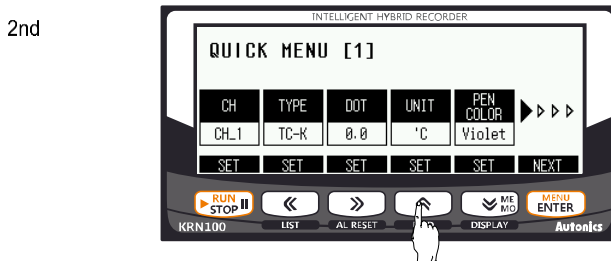

After completing the setting, press the SAVE (**ME MO**) key at QUICK MENU[4] and save the settings. It returns to RUN mode.

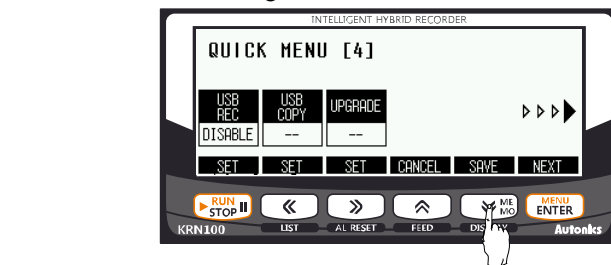

Ex.

1st
In case of CH1, recording as input type=TC-U, low-limit input value=300, standard record speed= 240mm/h

Press the **MENU ENTER** key in RUN mode to enter QUICK MENU.

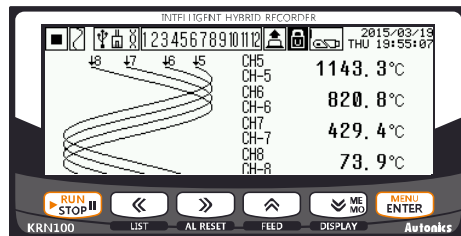

Press the SET (←) key at QUICK MENU [1] and below screen is displayed. Set input type [TYPE] as TC-U by pressing SET (↑), (↓) keys and press the (MENU ENTER) key.

2nd

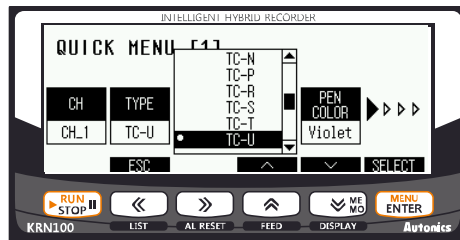

Press the NEXT (MENU ENTER) key once and it moves to QUICK MENU [2]. Press the SET (←) key using (←), (→), (↑), (↓) keys to set low-limit input range [LOW RANGE] as 300. Press the (MENU ENTER) key.

3rd

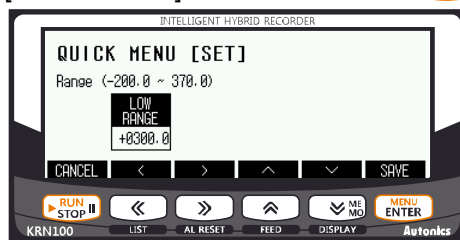

Press the NEXT (MENU ENTER) key once and it moves to QUICK MENU [3]. Press the SET (←) key and set standard record speed [PRINT SPEED] as 240mm/h. Press the (MENU ENTER) key.

4th

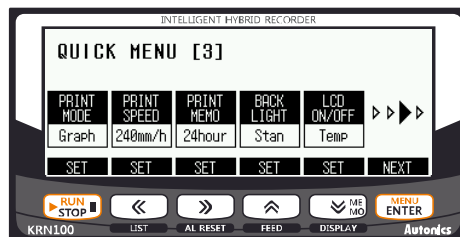

5th

Press the NEXT (MENU ENTER) key once and it moves to QUICK MENU [4]. Press the SAVE (ME MO) key to save the settings of QUICK MENU [1] to [4] and it returns to RUN mode.

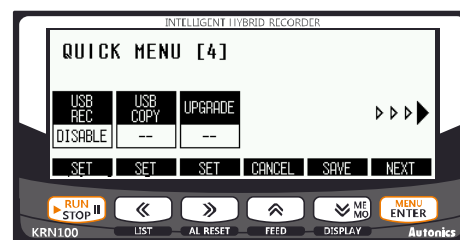

7.3.3 Parameter

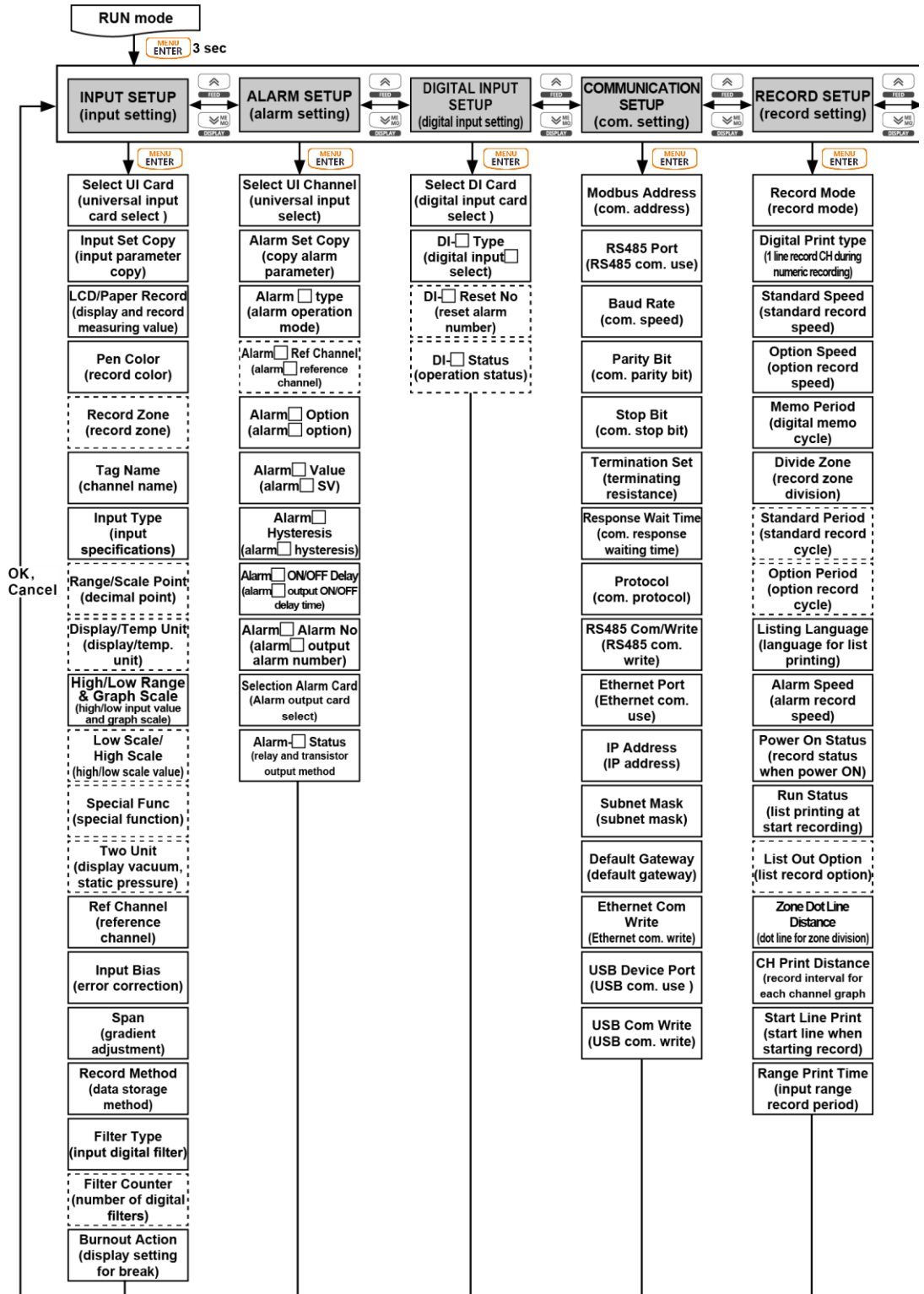

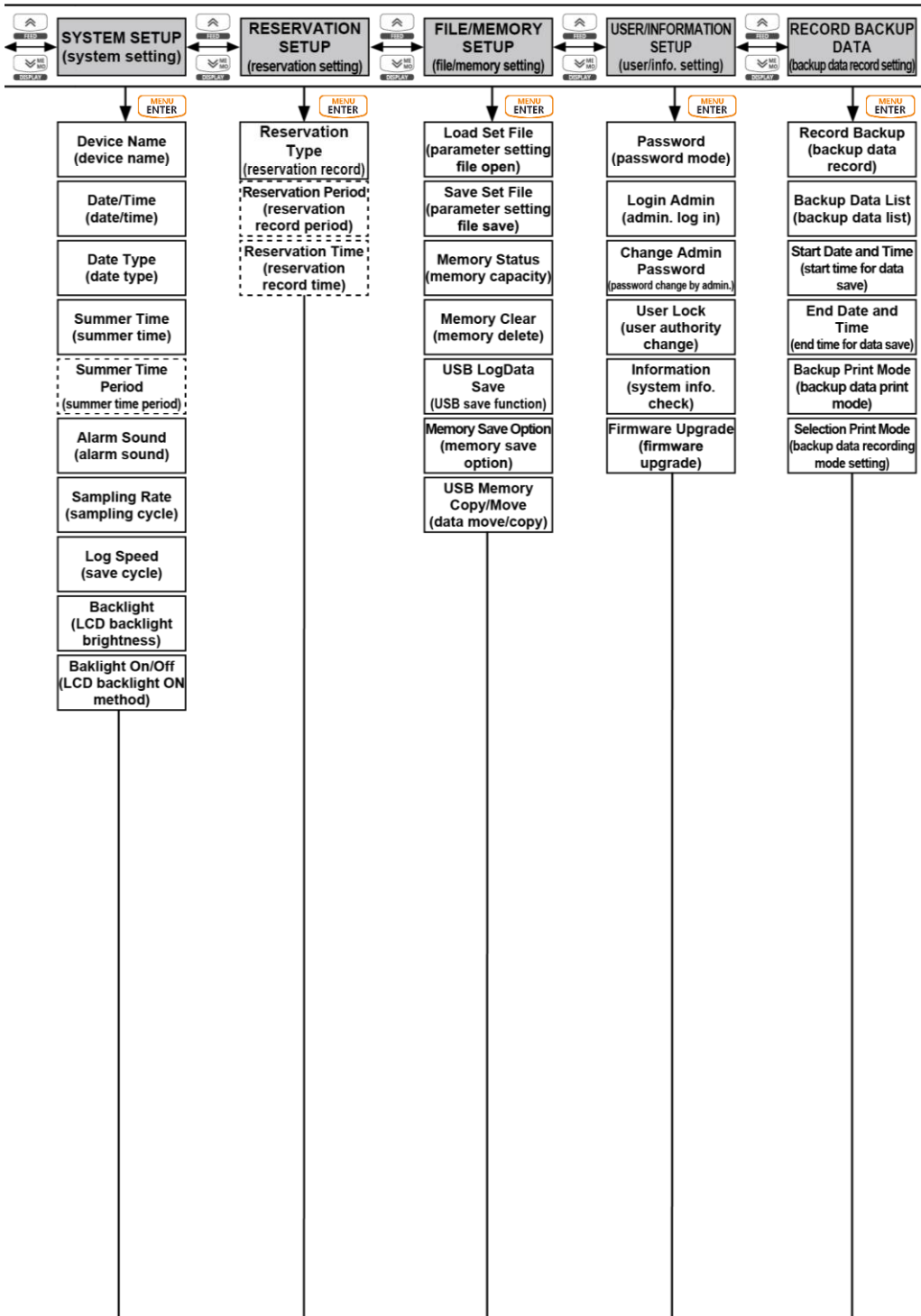

※Dot parameters may or may not appear, depending on the other parameter setting.

8 Parameter detail setup

8.1 INPUT SETUP(Input setting)

You can set details for input specification and scale by universal input channel, record method, input digital filter, input error correction, etc.

Move to INPUT SETUP with ,  keys, press  key to enter INPUT SETUP.

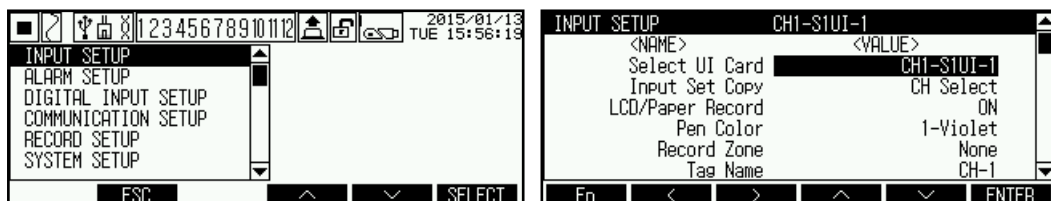

Parameter list

Parameter	Setting range	Factory default
Select UI Card (Select universal input card)	CH□-S□UI-□	Automatically set
Input Set Copy (Copy input parameter)	None, CH□-S□UI-□	CH Select
LCD/Paper Record (Display and record measuring value)	OFF ↔ ON	ON
Pen Color (Record color)	1-Violet ↔ 2-Red ↔ 3-Black ↔ 4-Green ↔ 5-Blue ↔ 6-Brown	Automatically set
Record Zone (Record zone)	None, 1 ↔ Zone n	None
Tag Name (Channel name)	None/1 to 6 characters	CH-1to12
Input Type (Input specification)	Refer to detail descriptions.	TC-K
Range/Scale Point (Decimal point)	TC, RTD: 0 ↔ 0.0	0.0
	Analog: 0 ↔ 0.0 ↔ 0.00 ↔ 0.000 ↔ 0.0000 If special function is two unit: 0 ↔ 0.0 ↔ 0.00	0.0
Display/Temp Unit (Display unit/Temperature unit)	TC, RTD: °C ↔ °F ↔ °K	°C
	Analog: Refer to detail descriptions.	%
High/Low Range & Graph Scale(Upper/Lower limit input value and graph scale value)	Low: Input range/Min. graph scale value to upper limit input value /Graph scale value (High Range/Graph Scale)– F.S. 5%	-200.0
	High: Lower limit input value/Graph scale value (Low Range/Graph Scale) + F.S 5% to input range/Max. graph scale value	1350.0
Low Scale/High Scale (Lower limit/Upper limit scale value)	Low: Set the range by set value of scale point	-
	High: Set the range by set value of scale point	-
Special Function (Special function)	TC, RTD: None ↔ Difference	None
	Analog: Linear ↔ Square ↔ Root ↔ Two Unit	
Two Unit (Display the degree of a vacuum, static pressure)	1 to 35	-
Reference Channel (Reference channel)	None ↔ CH□-S□UI-□	-

Parameter	Setting range	Factory default
	(Activates connected universal input(2 channel per one card))	
Input Bias(Error correction)	-999.9 to 999.9	0.0
Span (Gradient adjustment)	0.100 to 5.000	-
Record Method (Data storage method)	Instant ↔ Average ↔ Minimum ↔ Maximum	Instant
Filter Type (Input digital filter)	None ↔ Moving	None
Filter Counter (The number of digital filter)	1 to 128	-
Burnout Action (Display setting for break)	OFF ↔ Up_Scale ↔ Down_Scale	OFF

※Shaded parameters are affected by set value of other parameters. Please refer to specific descriptions of each parameter.



Note

When changing set value of Input Type(input type) parameter,



Range/Scale Point(Decimal point position)
 Display/Temp Unit(Display unit/Temperature unit)
 Low Range & Graph Scale (Lower limit input value and graph scale value)
 High Range & Graph Scale (Upper limit input value and graph scale value)
 Low Scale(Analog lower limit scale value)
 High Scale(Analog upper limit scale value)
 Special Function (Input special function)
 parameters' set values are reset.

8.1.1 Select UI Card (Select universal input card)

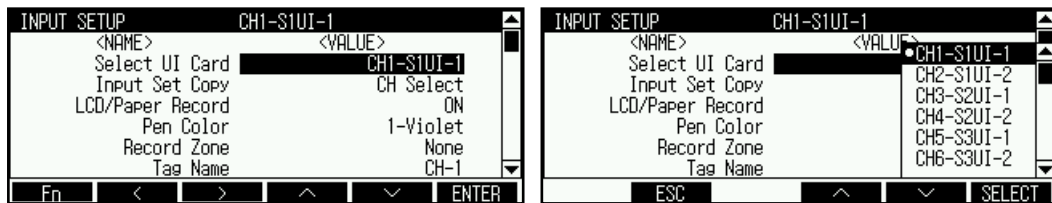

Select the channel of universal input card (KRN-UI2) to be set.

One universal input card has two channels.

KRN100 automatically searches slot connected universal input card (KRN-UI2) and displays as channel as soon as power is ON.

Channel name form is as below.

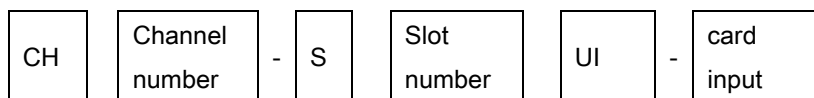

Ex.

CH06-S3UI-2: It means 6th channel and 2nd input of 3rd slot connected universal input card.

8.1.2 Input Set Copy (Copy input parameter)

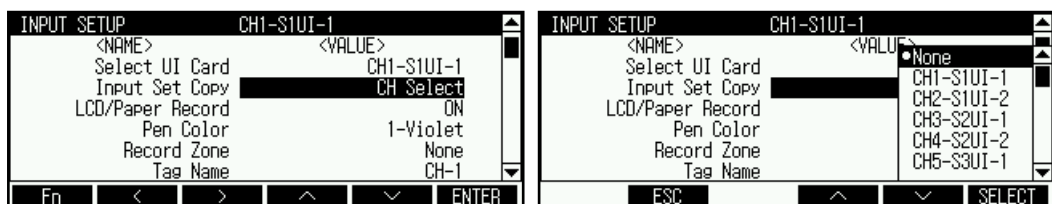

You do not need to repeat the setting of same parameter for each channel. KRN100 copies set values of the set-completed channel to other channels.

Copyable parameters are as following.

Input Type (Input specification)	Range/Scale point (Decimal point)
Display/Temp Unit (Display/Temperature unit)	Low Scale (Lower limit scale)
High Scale (Upper scale)	Special Function (Special function)
Two Unit (Display the degree of a vacuum, static pressure)	Reference Chanel (Reference channel)
Input Bias (Error correction)	Span (Gradient adjustment)
Record Method (Data storage method)	Filter Type (Input digital filter)
Filter Counter (The number of digital filter)	Burnout Action (Display setting for break)
High Range & Graph Scale (Upper limit input value and graph scale value)	Low Range & Graph Scale (Lower limit input value and graph scale value)

- Setting range: None/CH□-S□UI-□
- Factory default: CH Select

8.1.3 LCD/Paper Record (Display and record measuring value)

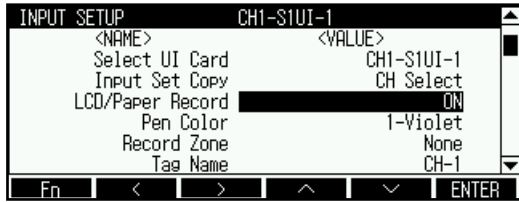

Set whether to record measuring value.

If you set ON, KRN100 displays and records measuring value on LCD screen, and recording paper. If you set OFF, KRN100 does not display and record measuring value on LCD screen, and recording paper.

- Setting range: ON ↔ OFF
- Factory default: ON

8.1.4 Pen Color (Record color)



Designate record color when recordingmeasuring value.

- Setting range: 1-Violet ↔ 2-Red ↔ 3-Black ↔ 4-Green ↔ 5-Blue ↔ 6-Brown
- Factory default: Automatically set

8.1.5 Record Zone (Record zone)



In case record mode is graph mode, you can select record zone for to graph measuring value when recording.

Setting range is set according to the set value of '8.5.6 Divide Zone (Record zone division)' from RECORD SETUP .

If the set is 'None', record zone is full width(100mm) of recording paper.

- Setting range: None, 1 ↔ Zone n (n: set value of Divide Zone (Record zone division))
- Factory default: None

8.1.6 Tag Name (Channel name)

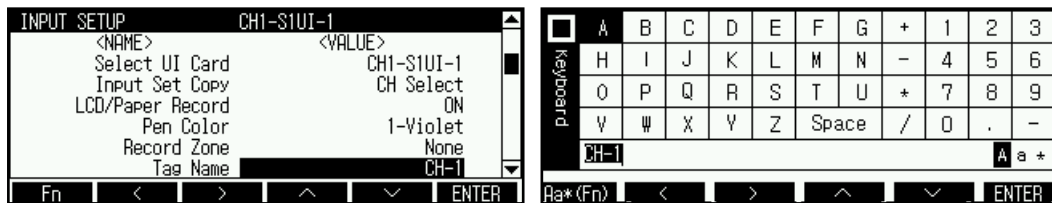

Designate channel name with virtual keyboard.

You can enter max. 6 characters with English capital letters, English small letters, and special characters.

- Setting range: 1 to 6 characters
- Factory default: CH-1 to CH-12(Channel number by slot)



Note

Some special character may be printed in low quality due to low print resolution.

8.1.7 Input Type (Input specification)

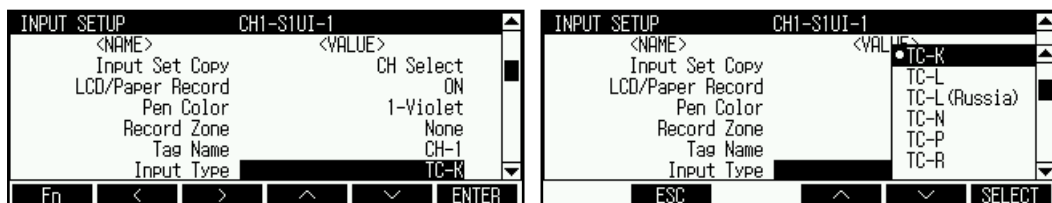

Set input specification of channel. Set input specification is total 27 such as thermocouple, RTD, voltage, and current. For more details, please refer to '2.3 Input specification and measuring range'. For jumper pin setting of universal input card (KRN-UI2) by input specification, refer to '4.2 I/O card'.

- Setting range: Refer to '2.3 Input specification and measuring range'
- Factory default: TC-K

8.1.8 Range/Scale Point (Decimal point)



In case Input Type(Input specification) is temperature sensor(thermocouple, RTD), set whether to display decimal point to measuring value. In case analog(voltage, current), set decimal point position of Low Scale(Lower limit scalevalue), High Scale(Upper limit scale value).

- Setting range
 - In case Input Type(Input specification) is temperature sensor(thermocouple, RTD): 0 ↔ 0.0
 - In case analog(current, voltage): 0 ↔ 0.0 ↔ 0.00 ↔ 0.000 ↔ 0.0000
- Factory default: 0.0



Note

If you want high accuracy display, select '0.0(decimal point)'. If you want to stable accuracy display, select '0 (no decimal point)'.

8.1.9 Display/Temp Unit (Display unit/Temperature unit)

In case Input Type(Input specification) is temperature sensor(thermocouple, RTD), temperature unit is activated. In case analog(current, voltage), display unit is activated.

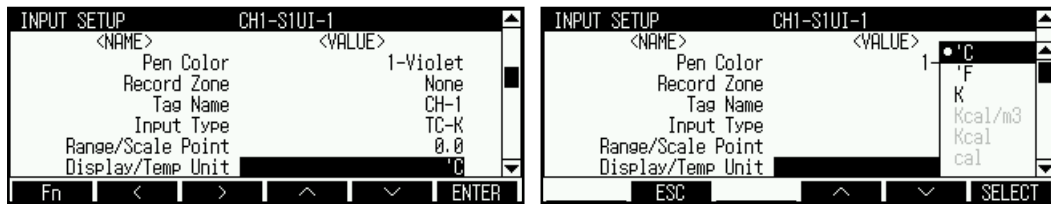

- Setting range
In case Input Type(Input specification) is temperature sensor(thermocouple, RTD): °C ↔ °F ↔ °K
In case analog : Refer to below table.
- Factory default: °C

Setting range in case analog (current, voltage)

No	Unit	No	Unit	No	Unit	No	Unit	No	Unit
1	°C	17	%	32	V	48	mA	64	User0
2	°F	18	Wt%	33	mV	49	A	65	User1
3	°K	19	mass%	34	μV	50	kg/cm ²	66	User2
4	Kcal/m ³	20	Vol%	35	kV	51	Pa	67	User3
5	Kcal	21	ppm	36	Ω	52	kPa	68	User4
6	cal	22	ppb	37	mΩ	53	MPa	69	User5
7	j	23	mol	38	μΩ	54	N/m ²	70	User6
8	Btu	24	Blank	39	s	55	N/mm ²	71	User7
9	l	25	lx	40	μs	56	inH ₂ O	72	User8
10	ml	26	cd	41	VA	57	mmH ₂ O	73	User9
11	t	27	lm	42	W	58	bar		
12	gal	28	cd/m ²	43	kW	59	Torr		
13	lb	29	rpm	44	MW	60	mmHg		
14	oz	30	Hz	45	Var	61	mmAq		
15	barrel	31	m ² /s	46	kVar	62	psi		
16	-	32	cp	47	MVar	63	Blank		

You can use user-defined unit image by selecting user-defined (User0 to User9) unit. Please refer to '9.4.2 User unit setting'.



Note

The unit with multiplier such as kg/cm² or complicated unit may be printed in low quality due to low print resolution.

8.1.10 High/Low Range & Graph Scale(Upper/Lower limit input value and graph scale value)

Set the actual used input range (Lower limit input value/Upper limit input value) in analog input.

If input range becomes small, the resolution also becomes low in proportion to total range.

Decimal point position is changed by 'Scale Point(Scale decimal point position)' setting.

(1) Low Range (Lower limit input value)

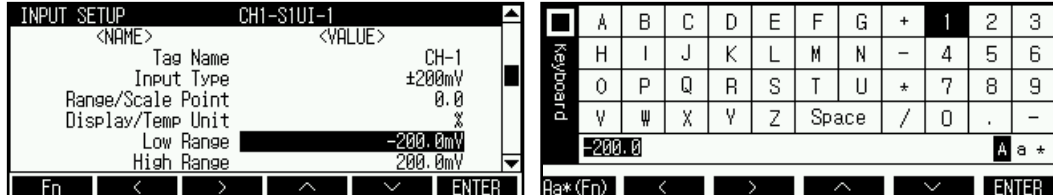

Set the actual used lower limit input value within input range of Input Type(Input specification).

- Setting range: Min. input range value to upper limit input value(High Range) – F.S. 5%
In case input range is 0 to 100°C, setting range is 0 to 95°C.
- Factory default: -

(2) High Range (Upper limit input value)

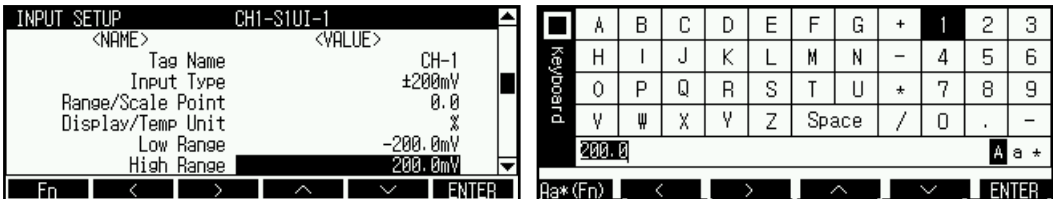

Set the actual used upper limit input value within input range of Input Type(Input specification).

- Setting range: Lower limit input value(Low Range) + F.S. 5% to max. input range value
In case input range is 0 to 100°C, setting range is 5 to 100°C.
- Factory default: -

Set the displayed graph scale value on recording paper and LCD in temperature sensor input type (Thermocouple, RTD), (They does not displayed in analog input type.).

You can designate the record range and record specific section as detail graph by these parameters. (If graph scale range is small, resolution is also lower in proportion to recording range.)

(3) Low Graph Scale (Lower limit graph scale value)

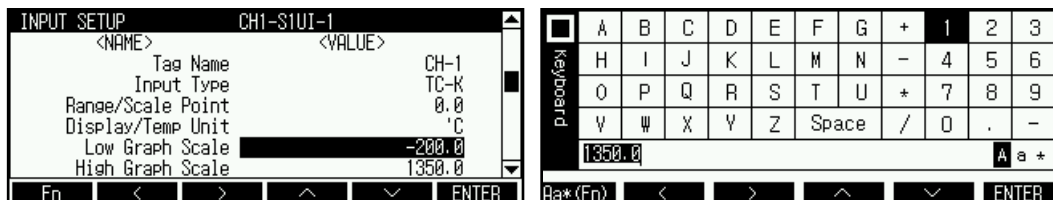

Within the input range of Input Type (Input specification), set lower limit graph scale value.

- Setting range: Min. value of input range to upper limit graph scale value (High Graph Scale) – F.S. 5%
When TC-K input range is -200.0 to 1350°C, setting range is -200.0 to 1272.5°C.
- Factory default: -200.0

(4) High Graph Scale (Upper limit graph scale value)

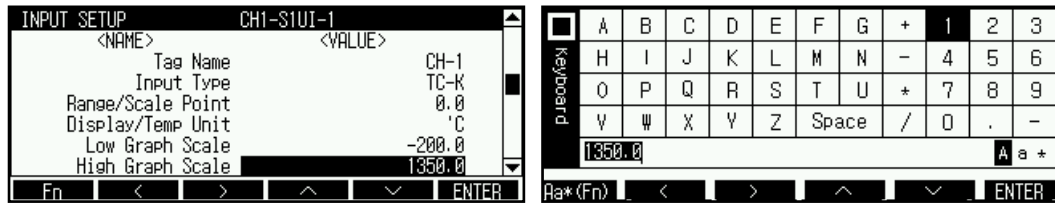

Within the input range of Input Type (Input specification), set upper limit graph scale value. They does not displayed in analog input type.

- Setting range: Lower limit graph scale value (Low Graph Scale) + F.S. 5% to Max. value of input range
When TC-K input range is -200.0 to 1350°C, setting range is -122.5 to 1350°C.
- Factory default: 1350.0

8.1.11 Low Scale/High Scale (Lower limit/Upper limit scale value)

This function is for set the desired display value based on measuring value. It is applied to analog (voltage, current) input type only.

As below figure, for example, measuring input value are 'a' and 'b' and the desired display value are 'A' and 'B'. In this case, about the input 'a' and 'b', it displays $a=A$, $b=B$ as linearly.

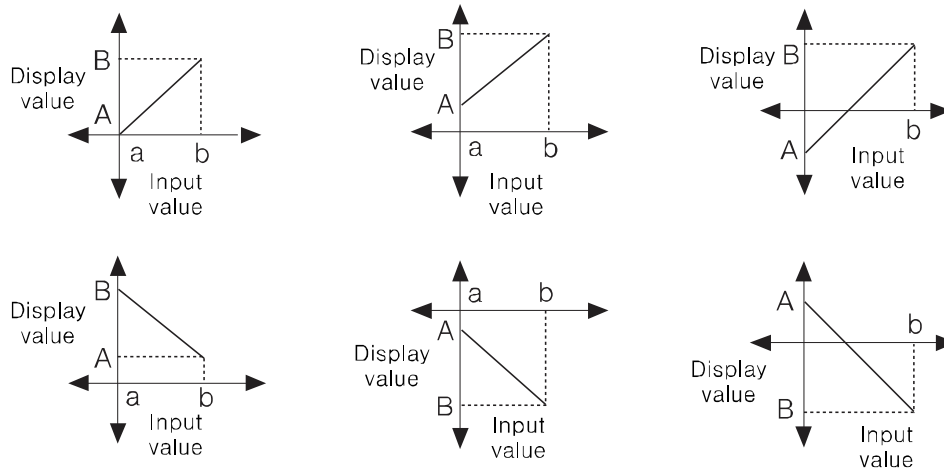

You can change display value about min./max. input value of measuring value.



In case input specification is 0-20mA

- Set Low Scale (Lower limit scale value) = 0.0, High Scale (Upper limit scale value) = 10.0, 20.0, 30.0, -20.0.

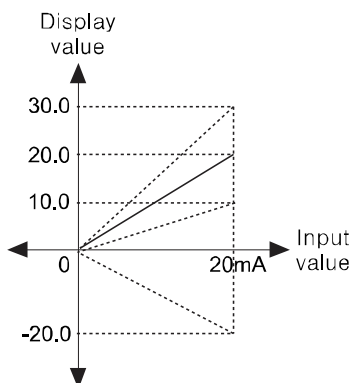

- Set Low Scale (Lower limit scale value) = 20.0, High Scale (Upper limit scale value) = -20.0.

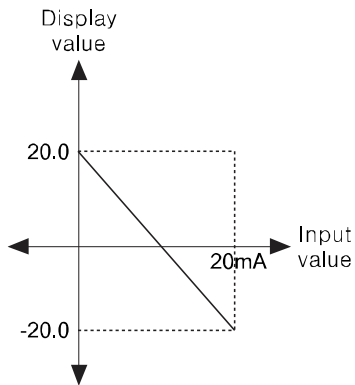

- Set Low Scale (Lower limit scale value) = -20.0, High Scale (Upper limit scale value) = 20.0.

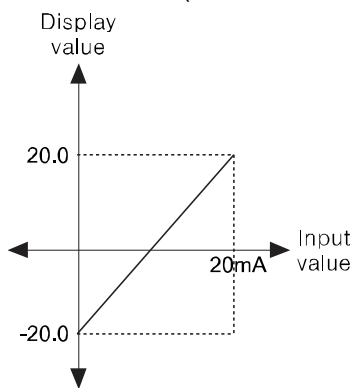

(1) Low Scale(Lower limit scale value)



Set scale value for lower limit input value (Low Range).

- Setting range: -99999 to 99999 ↔ -9999.9 to 9999.9 ↔ -999.99 to 999.99 ↔ -99.999 to 99.999 ↔ -9.9999 to 9.9999 (Depending on Scale Point setting, the range is different.)
- Factory default: -

(2) High Scale(Upper limit scale value)

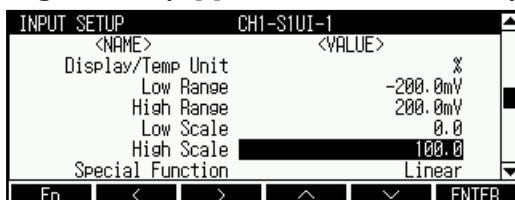

Set scale value for upper limit input value (High Range).

- Setting range: -99999 to 99999 ↔ -9999.9 to 9999.9 ↔ -999.99 to 999.99 ↔ -99.999 to 99.999 ↔ -9.9999 to 9.9999 (Depending on Scale Point setting, the range is different.)
- Factory default: -

8.1.12 Special Function (Special function)

INPUT SETUP		CH1-S1UI-1
<NAME>	<VALUE>	
Display/Temp Unit	%	
Low Range	-200.0mV	
High Range	200.0mV	
Low Scale	0.0	
High Scale	100.0	
Special Function	Linear	

It displays the applied measuring value of the set special function.
Depending on Input Type(Input specification), applicable special function is different.

- Setting range
When input type(input specification) is
temperature sensor (thermocouple, RTD): None ↔ Difference
analog (voltage, current): Linear ↔ Root ↔ Squire ↔ Two Unit (Two Unit is displayed
when Input Type (input specification) is set as 0-20mA, 4-20mA.)
- Factory default: None

Below graph's patterns are liner, root, square for analog input.



Ex.

Lower limit input value: -5V, Upper limit input value: +5V, Lower limit scale: -1000, Upper limit scale: 1000

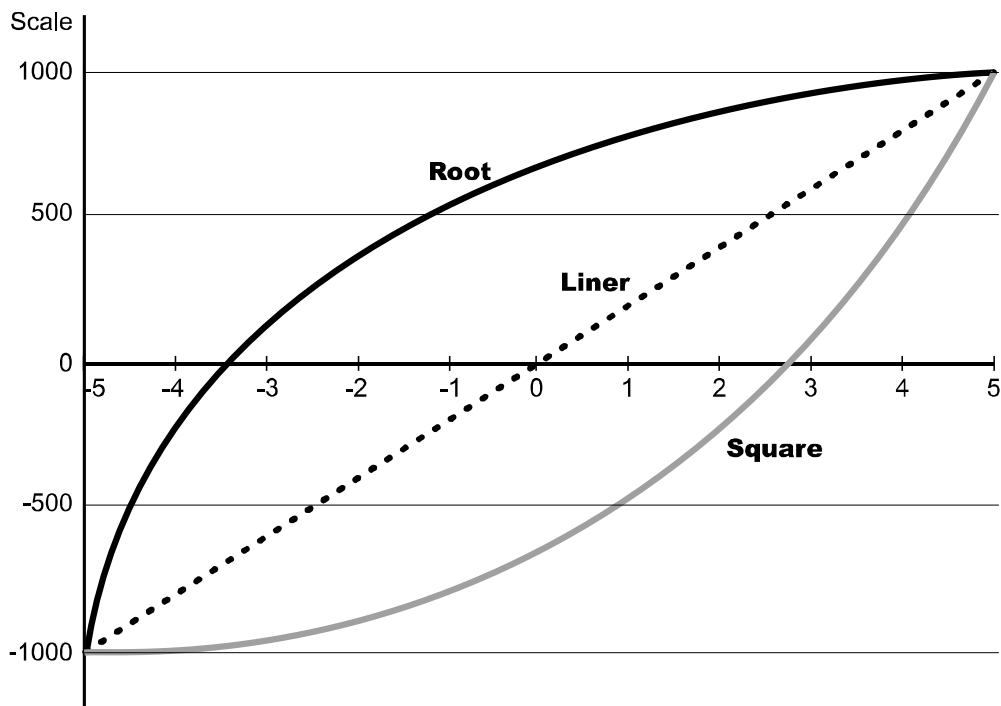

(1) Difference(Deviation)

It is available to set when Input Type(input specification) is temperature sensor (thermocouple, RTD). It displays the deviation of Reference Channel (Reference channel) measuring value.

(Display value = standard channel measuring value – reference channel measuring value)

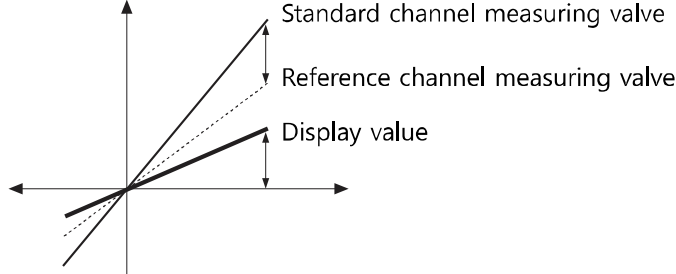

- The set channel as analog (current, voltage) of Input Type (Input specification) is not able to set as Reference Channel (reference channel).
- If there is no set reference channel, it displays standard channel measuring value.
- If any one of reference channel, or standard channel is break (BURN), upper limit value (HHHH), lower limit value(LLLL) status, it displays as correspond value. If you select the channel which is used Difference function as reference channel, it displays the value based on calculating actual measuring value, not display value of reference channel.

(2) Linear

It applies lower limit scale and upper limit scale to lower limit input value and upper limit input value and displays this values.



Ex.

In case lower limit input value: -5V, Upper limit input value: +5V and in case lower limit scale: -1000, upper limit scale: 1000 if current input value is 2V, display value is 400.

Display value =

$$\frac{\text{Input value} - \text{Lower limit input value}}{\text{Upper limit input value} - \text{Lower limit input value}} \times (\text{Upper limit scale} - \text{Lower limit scale}) + \text{Lower limit scale}$$

$$400 = \frac{7}{10} \times 2000 - 1000$$

(3) Root

In case voltage, current input type, this mode is used when input value is calculated by Root ($\sqrt{\quad}$) for the desired display value. Differential pressure signal of differential pressure flow meter is calculated Root($\sqrt{\quad}$) for the to-be measured flux. This function is used to measure flux by input value.



Ex.

In case lower limit input value: -5V, upper limit input value: +5V and in case lower limit scale: -1000, upper limit scale: 1000, if current input value is 2V, display value is approx. 673.32.

$$\text{Display value} = \sqrt{\frac{\text{Input value} - \text{Lower limit input value}}{\text{Upper limit input value} - \text{Lower limit input value}}} \times (\text{Upper limit scale} - \text{Lower limit scale}) + \text{Lower limit scale}$$

$$673.32 = \sqrt{\frac{7}{10}} \times 2000 - 1000$$

(4) Square

In case of voltage, current input type, this mode is used when input value is calculated by square for the desired display value. Reverse of Root, flux signal is calculated by square for differential pressure signal.



Ex.

In case lower limit range: -5V, upper limit range: +5V and
in case lower limit scale: -1000, upper limit scale: 1000,
if current input value is 2V, display value is -20.

$$\text{Display value} = \left(\frac{\text{Input value} - \text{Lower limit input value}}{\text{Upper limit input value} - \text{Lower limit input value}} \right)^2 \times (\text{Upper limit scale} - \text{Lower limit scale}) + \text{Lower limit scale}$$

$$-20 = \left(\frac{7}{10} \right)^2 \times 2000 - 1000$$

(5) Two Unit

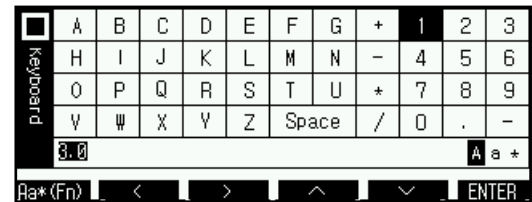

For compound pressure, if input pressure is lower than atmospheric pressure(0), it displays the degree of a vacuum with mmHg unit. If input pressure is higher than or same as atmospheric pressure(0), it displays positive pressure with kg/cm² unit.

When using Two Unit function, lower limit value is fixed as -760mmHg and kg/cm² value is able to set within setting range 1 to 35.

Two Unit limits scale point as 0 ↔ 0.0 ↔ 0.00. When using Two Unit, display unit is automatically changed as mmHg or kg/cm².

The calculation with Record Method (Data storage method) and Filter type (Input digital filter) is impossible and ignored due to different type of two unit value.

- Setting range: 1 to 35
- Factory default: -



Ex.

If pressure range is -760mmHg to 3kg/cm², and pressure transmitter outputs 4-20mA, for 4mA input it displays -760 mmHg, 8mA input is unit changing point. For 20mA input, it displays 3kg/cm².

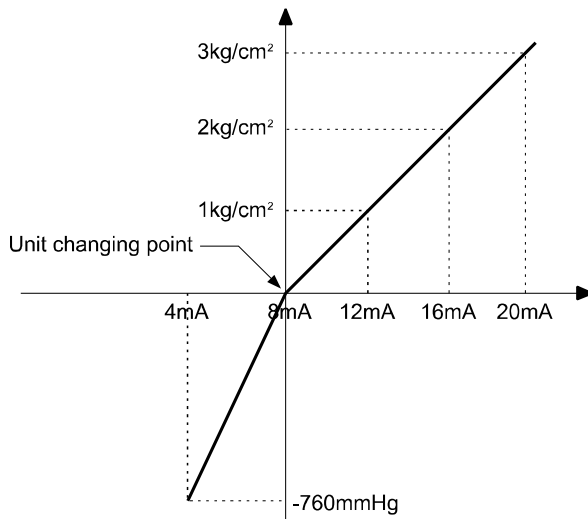

Range	Unit changing point (mA)
-760mmHg to 1kg/cm ²	12.130
-760mmHg to 5kg/cm ²	6.740
-760mmHg to 10kg/cm ²	5.498
-760mmHg to 15kg/cm ²	5.031
-760mmHg to 20kg/cm ²	4.786
-760mmHg to 25kg/cm ²	4.635
-760mmHg to 30kg/cm ²	4.533
-760mmHg to 35kg/cm ²	4.459

 **Note**

$$\text{Unit changing point} = \left(\frac{16}{X+1.033} \times Y \right) + 4$$

16	4-20 mA output interval
X	Max. pressure range value (E.g. For 760 to 3 kg/cm ² , it is " 3 ".)
1.033	Converted value from 760 mmHg to kg/cm ² unit value (same unit)
Y	Use pressure + 1.033 (E.g. Use pressure is '0', Y is 1.033.)
4	Output value for zero, 4.00mA

- Setting range
 In case Input Type(Input specification) is temperature sensor(thermocouple, RTD): None ↔ Difference
 In case Input Type(Input specification) is analog(voltage, current): Linear ↔ Root ↔ Square ↔ Two Unit (Two Unit is activated for current input(0-20mA, 4-20mA).)
- Factory default: None

8.1.13 Reference Channel (Reference channel)

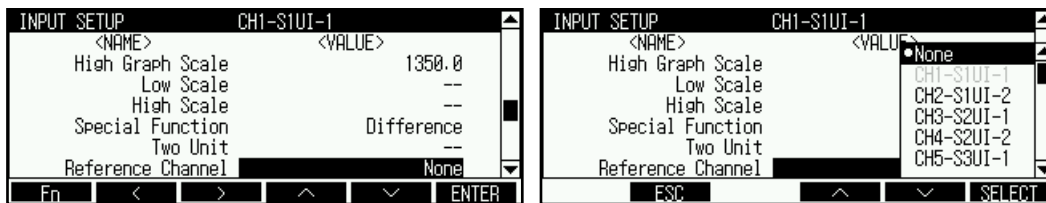

In case Input Type(Input specification) is temperature sensor(thermocouple, RTD), set Special Function(special function) as Difference to set reference channel.

- Setting range: None / CH□-S□UI-□
- Factory default: -

8.1.14 Input Bias(Error correction)

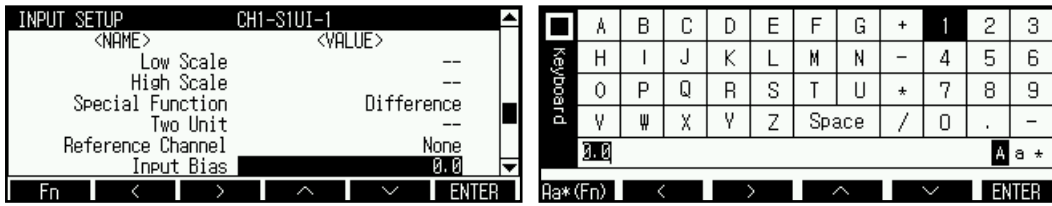

This function is for error correction from input (thermocouple, RTD, voltage, current) not from this recorder.

When temperature sensor cannot be installed near measured subject, there may be the temperature deviation between temperature sensor area and measured subject area. This function calculates and corrects this errors. Several kinds of temperature sensor has specified grade. High accuracy type is high price and ordinary product is generally used. To correct input by measuring error from each helps more accurate temperature measurement.

For using this error correction function, you should accurately measure the deviation from input part , at first. If this deviation is not correct, the error may be higher.

- Setting range: -9999 to 9999 ↔ -999.9 to 999.9 ↔ -99.99 to 99.99 ↔ -9.999 to 9.999 ↔ -0.9999 to 0.9999 (Depending on the set scale point, range is different.)
- Factory default: 0.0



In case actual temperature is 80°C but display temprature from recorder is 78°C, set Input Bias(Error correction) as '2' and display temperature is 80°C.

8.1.15 Span (Gradient adjustment)

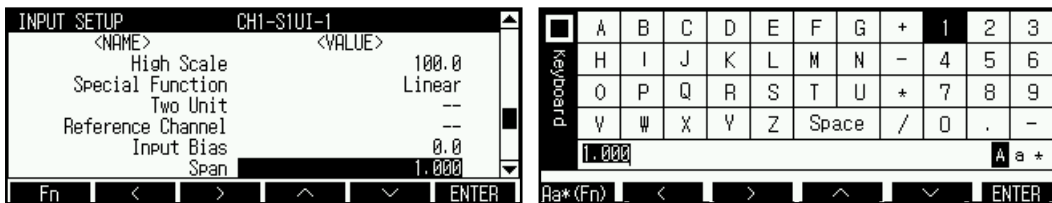

This menu is for adjusting upper limit error by regulating display value which is about measuring value or applied scale.



In case Low Scale(Lower limit scale value) and High Scale(Upper limit scale value) are fixed, and Span (Gradient adjustment) is only set. When Input range is 0-10V, Low Scale(Lower limit scale) value is 0.00, and High Scale(Upper limit scale) value is 10.00.

If changing gradient adjustment value as 0.500, 1.000 or 1.500, display value by each changed gradient adjustment value is below.

Lower limit scale value	Upper limit scale value	Gradient adjustment value	Range of display value	Same result =	Lower limit scale value	Upper limit scale value	Gradient adjustment value	
0.00	10.00	0.500	0.00 to 5.00			0.00	5.00	1.000
0.00	10.00	1.000	0.00 to 10.00			0.00	10.00	1.000
0.00	10.00	1.500	0.00 to 15.00			0.00	15.00	1.000

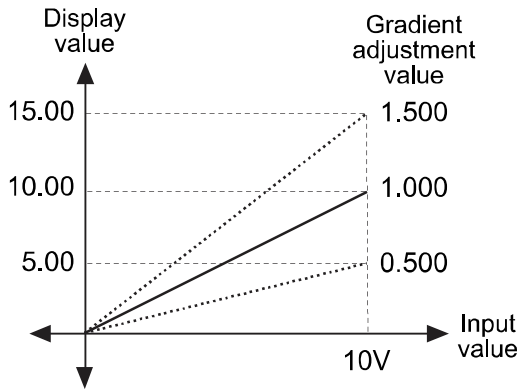

In case Low Scale(Lower limit scale value) and High(Upper limit scale value) are fixed, and Span (Gradient adjustment) is only set (reverse gradient). When Input range is 0-10V, Low Scale(Lower limit scale) value is 10.00, High Scale(Upper limit scale) value is 0.00.

If changing gradient adjustment value as 0.500, 1.000, or 1.500, display value by each changed gradient adjustment value is below.

Lower limit scale value	Upper limit scale value	Gradient adjustment value	Range of display value
10.00	0.00	0.500	10.00 to 5.00
10.00	0.00	1.000	10.00 to 0.00
10.00	0.00	1.500	10.00 to -5.00

Same result =

Lower limit scale value	Upper limit scale value	Gradient adjustment value
10.00	5.00	1.000
10.00	0.00	1.000
10.00	-5.00	1.000

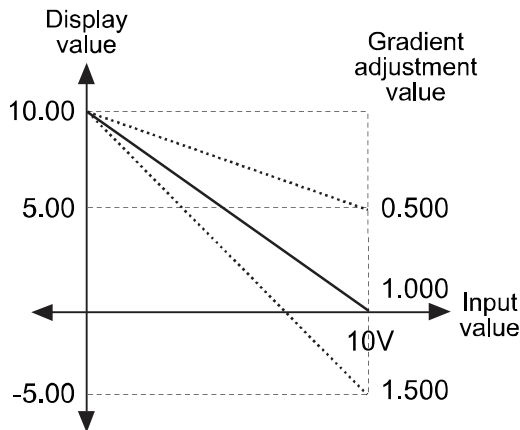

8.1.16 Record Method (Data storage method)



Set storage method for measured data by channel to inner/external memory.
Display and print method is Record Method.

Set value	Description
Instant(Instant value)	Saves measuring value by every record period (Log Speed)
Average(Average value)	Saves averaged measuring value during record period (Log Speed).
Minimum(Min. value)	Saves min. measuring value during record period (Log Speed).
Maximum(Max. value)	Saves max. measuring value during record period (Log Speed).

- Setting range: Instant ↔ Average ↔ Minimum ↔ Maximum
- Factory default: Instant

8.1.17 Filter Type (Input digital filter)



In some applications the fluctuating measuring input causes the display value to fluctuate. In this case accurate display/record is disable. This function is able to make display value stable by input digital filter.

Input digital filter uses moving average method (Moving Average Filter). It does not affect to display period but display value may be different with input value.

- Setting range: None ↔ Moving
- Factory default: None

8.1.18 Filter Counter (The number of digital filter)

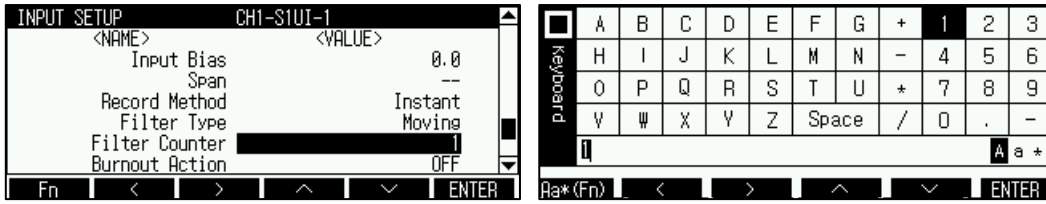

Designate the number of sampling which apply to digital filter.

When you set Filter Type(Input digital filter), this parameter is activated.

- Setting range: 1 to 128
- Factory default: -



When the set value of input digital filter is '4', it does moving average input sampling values for 0.1 sec (100ms) and displays this value.

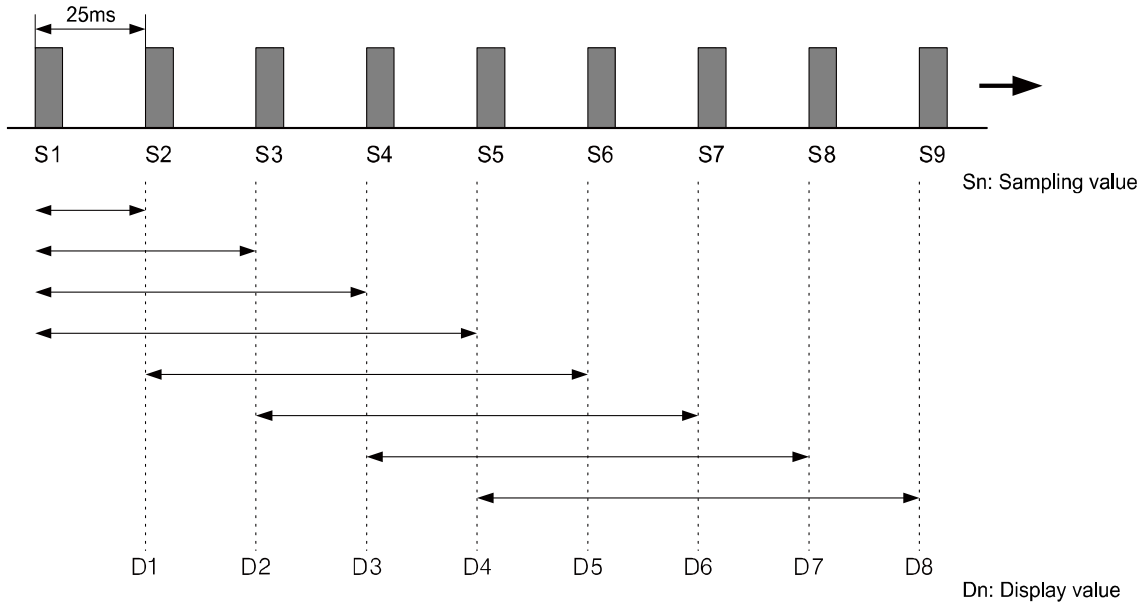

$$D1=S1$$

$$D2 = \frac{S1 + S2}{2}, D3 = \frac{S1 + S2 + S3}{3}$$

Display values of D1, D2, D3 is the initial operation before averaging 4 sampling values.

$$D4 = \frac{S1 + S2 + S3 + S4}{4}, D5 = \frac{S2 + S3 + S4 + S5}{4}$$

$$D6 = \frac{S3 + S4 + S5 + S6}{4}, D7 = \frac{S4 + S5 + S6 + S7}{4}$$

$$D8 = \frac{S5 + S6 + S7 + S8}{4}$$

8.1.19 Burnout Action (Display setting for break)



In case Input Type(Input specification) is temperature sensor(thermocouple, RTD), set alarm operation and alarm option for break input. (In case Input Type(Input specification) is analog(voltage, current), this function does not operate.)

Set value	Description
OFF	When input break, after moving display value downward or upward according to circuit structure ※1 (max. or min. value in graph record state) it displays BURN.
Up Scale	When input break, after moving display value only upward (records max. value in graph record state) it displays BURN.
Down Scale	When input break, after moving display value only downward (records min. value in graph record state) it displays BURN.

- Setting range: OFF ↔ Up Scale ↔ Down Scale
- Factory default: OFF





Note

According to circuit structure, when thermocouple(Thermocouple) temperature sensor, RTD(RTD) temperature sensor's A-B terminal or voltage input $\pm 60\text{mV}$, $\pm 200\text{mV}$ input is break, it displays Down Scale.
When RTD(RTD) temperature sensor's B-B' terminal input is break, it displays Up Scale.

8.2 ALARM SETUP (Alarm setting)

You can set alarm output specification such as alarm operation mode and alarm option by input channel, alarm ON/OFF delay, alarm output relay, relay contact, etc.

Move to ALARM SETUP with ,  keys, press  key to enter ALARM SETUP.

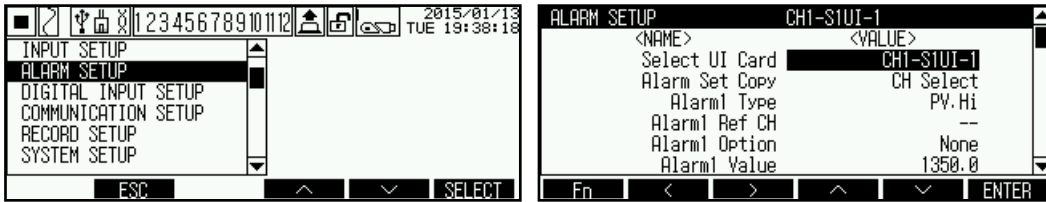

Parameter list

Parameter	Setting range	Unit	Factory default
Select UI Card (Select universal card input)	CH□-S□UI-□	-	Automatically set
Alarm Set Copy (Copy alarm parameter)	No Select/ CH□-S□UI-□	-	CH Select
Alarm□ Type(Alarm□ operation mode) ^{*1}	OFF ↔ PV.Hi ↔ PV.Lo ↔ DV.Hi ↔ DV.Lo ↔ SBA ↔ P.END	-	Alarm1 Type: PV.Hi Alarm2 Type to Alarm4 Type: None
Alarm□ Ref Channel(Alarm□ reference channel)	None / CH□-S□UI-□	-	-
Alarm□ Option(Alarm□ option) ^{*1}	None ↔ Latch ↔ StBy ↔ La+St	-	None
Alarm□ Value(Alarm□ set value) ^{*1}	F.S. of INPUT TYPE by channel	Digit	Alarm1 Value: 1350.0 Alarm2 Value to Alarm4 Value: -
Alarm□ Hysteresis(Alarm□ hysteresis) ^{*1}	F.S. of INPUT TYPE by channel	Digit	0.0
Alarm□ ON/OFF Delay(Alarm□ ON/OFF output delay time) ^{*1}	0 to 3600	sec	0s
Alarm□ Alarm No(Alarm□ output alarm number) ^{*1}	None / S□AO-□	-	None
Select Alarm Card(Select alarm output card)	-	-	Automatically set
Alarm-□ Status(Relay and transistor output method) ^{*1}	N.O.↔N.C.	When connecting Relay type KRN-AR4 (alarm output card), AL1 to AL4 are activated. When connecting transistor type KRN-AT6 (alarm output card), AL1 to AL6 are activated.	N.O.
	N.O.↔N.C.		N.O.
	N.O.↔N.C.		N.O.
	N.O.↔N.C.		N.O.
	N.O.↔N.C.		N.O.
	N.O.↔N.C.		N.O.

※1. Alarm□ Type to Alarm□ Alarm No parameters are displayed as the number of connected alarm output card.

※Shaded parameters are affected by set value of other parameters. Please refer to specific descriptions of each parameter.

8.2.1 Select UI Card (Select universal card input)

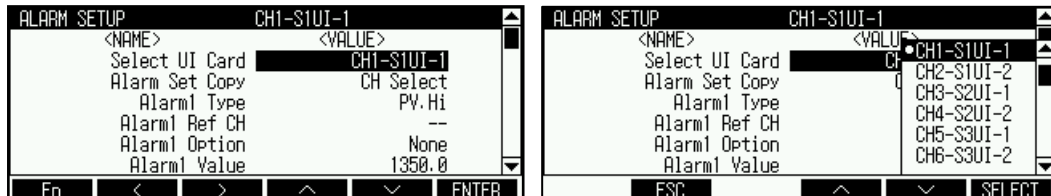

Select the channel of universal input card (KRN-UI2) to be set.

One universal input card has two channels.

KRN100 automatically searches connected input/output card on slot power when power ON and recognizes the number of universal input card(KRN-UI2).

- Setting range: CH□-S□UI-□(Activated connected universal input(2 channels per input card))
- Factory default: Automatically set

8.2.2 Alarm Set Copy (Copy alarm parameter)



You do not need to set same parameter settings repeatedly for other channels. This function is to copy set value of alarm parameter of the set channel and applies it to other channels. Copiable parameters are as below.

Alarm□ Type (Alarm□ operation mode)	Alarm□ Ref Channel (Alarm□ reference channel)	Alarm□ Option (Alarm□ option)
Alarm□ Value (Alarm□ Set value)	Alarm□ Hysteresis (Alarm□ hysteresis)	Alarm□ ON Delay (Alarm□ ON delay time)
Alarm□ OFF Delay (Alarm□ OFF delay time)	Alarm□ Alarm No (Alarm□ output relay number)	

- Setting range: No Select/CH□-S□UI-□(Activated connected universal input(2 channels per input card))
- Factory default: CH Select

8.2.3 Alarm □ Type (Alarm □ operation mode)

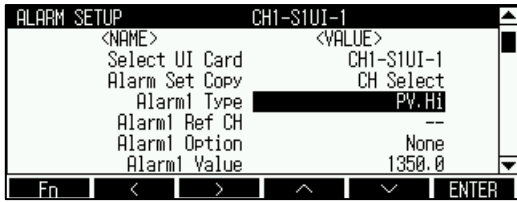

Designate alarm operation when alarm ON.
You can set up to 4 operations by each channel and alarm operations are as below.

Type	Record	Alarm operation	Description
1	No alarm	-	-
2	Absolute value upper limit alarm (▲)	Alarm set value: 90°C OFF ↓ H ↑ ON 90°C PV100°C	If display value is same or higher than alarm set value, alarm output turns ON.
3	Absolute value lower limit alarm (▼)	Alarm set value: 90°C ON ↑ H ↓ OFF 90°C PV100°C	If display value is same or lower than alarm set value, alarm output turns ON.
4	Deviation upper limit alarm (△)	Alarm set value: -10°C OFF ↓ H ↑ ON PV 110°C Reference channel PV 110°C	If the deviation between display value and the display value of reference channel is same or higher than alarm set value, alarm output turns ON.
		Alarm set value: 10°C OFF ↓ H ↑ ON Reference channel PV 90°C PV 100°C	
5	Deviation lower limit alarm (▽)	Alarm set value: 10°C ON ↑ H ↓ OFF Reference channel PV 100°C PV 110°C	If the deviation between display value and the display value of reference channel is same or lower than alarm set value, alarm output turns ON.
		Alarm set value: -10°C ON ↑ H ↓ OFF PV 90°C Reference channel PV 100°C	
6	Input break alarm (S)	SBA	In case input is not connected, or input cable is break during controlling, alarm output turns ON. You can check whether input cable is break by external contact of alarm output using buzzer or other devices.
7	No recording paper alarm (P)	P.END	In case of no recording paper during recording, record operation stops and this alarm output turns ON. (Measuring value is saved at system memory automatically.) Alarm is automatically cleared when recording paper is replaced (in case of general alarm). P.END BACKUP PRINT window is activated and it is available to output backup data.

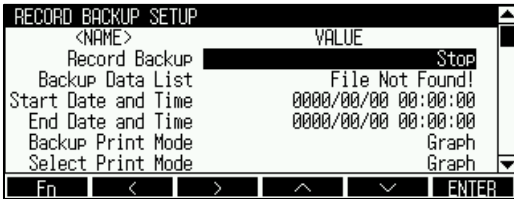

※ H: Alarm output hysteresis(Hysteresis)

If even one alarm occurs, alarm ON icon marks the specified channel to check whether alarm has occurred.

(1) Record Mode(Record mode) is Graph

It records alarm sign, alarm operation mode, and occurrence time on recording paper with the set record color in 'Pen Color' of INPUT SETUP. Alarm sign is recorded at alarm set value position.

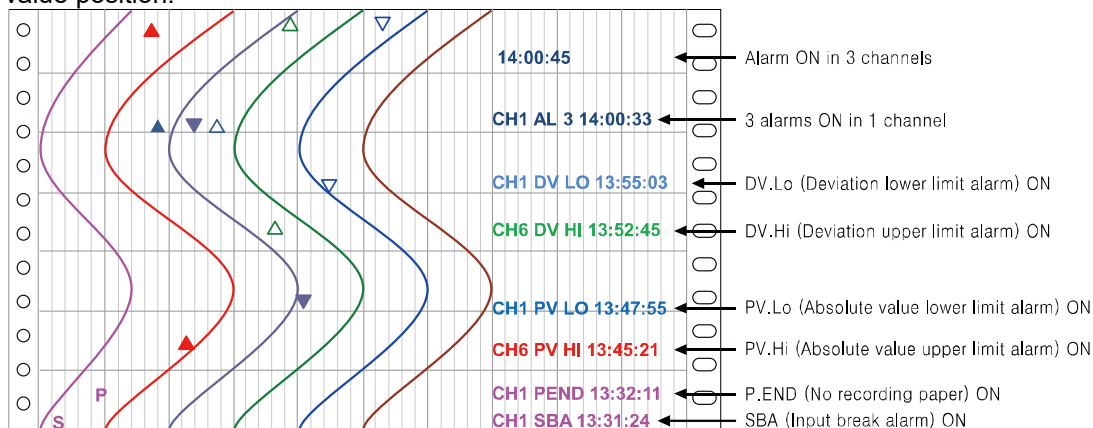

Alarm ON from 1 channel,	Records alarm sign of corresponding channel's graph. Records also alarm and time information at right.
Alarm ON at the same time from over 2 channels,	Records alarm sign of corresponding channel's graph. Records only time information at right.
Over 2 alarms ON from 1 channel,	Records alarm sign and 'CH1 AL-□(the number of alarm) 14:00:33' form.

If alarm occurs at digital memo time, memo information includes alarm information. Therefore, as below figure, alarm sign, alarm information, time information is not recorded and is replaced as digital memo.

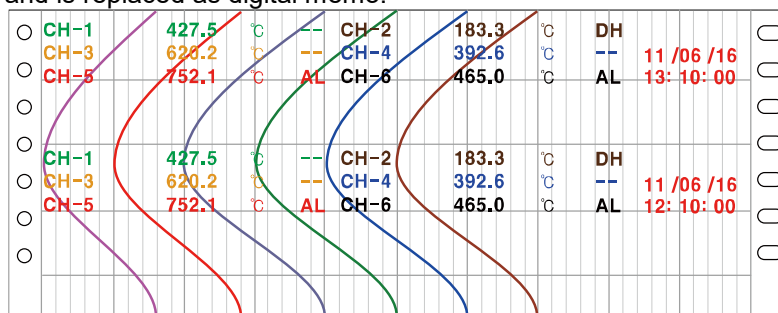

[Alarm sign]

No.	Name	Alarm sign
1	Absolute value upper limit alarm	▲
2	Absolute value lower limit alarm	▼
3	Deviation upper limit alarm	△
4	Deviation lower limit alarm	▽
5	Input break alarm	S
6	No recording paper	P

(2) Record Mode(Record mode) is Digital

It records alarm ON channel, data information, alarm abbreviation, time with the set record color of corresponding channel.

In front of ON time, as below, 'A' is marked to mean the data by alarm.

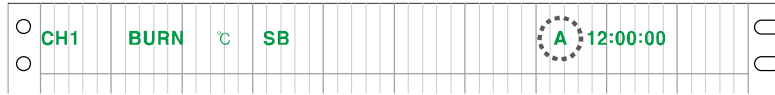

After alarm recording, if it maintains same alarm or alarm is cleared, it does not record the relevant data.

In case of record by digital memo, it prints alarm abbreviation of occurring alarm as below.

No.	Name	Alarm abbreviation	Note
1	Absolute value upper limit alarm	PH	-
2	Absolute value lower limit alarm	PL	-
3	Deviation upper limit alarm	DH	-
4	Deviation lower limit alarm	DL	-
5	Input break alarm	SB	-
6	No recording paper	PE	-
7	Several alarm ON	AL	It is used when printing 2 channels in one line.

- Setting range: OFF ↔ PV.Hi ↔ PV.Lo ↔ DV.Hi ↔ DV.Lo ↔ SBA ↔ P.END
- Factory default
Alarm1 Type: PV.Hi, Alarm2 Type to Alarm4 Type: None

8.2.4 Alarm Ref Channel(Alarm reference channel)

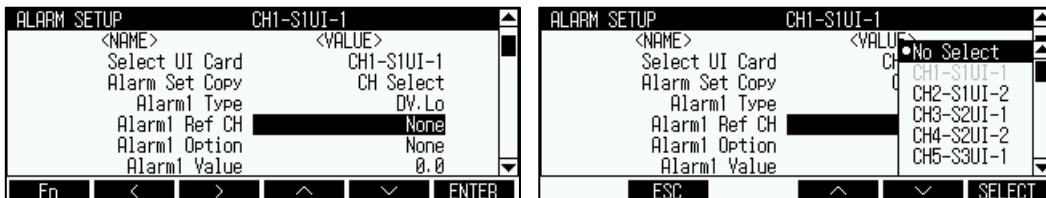

Designate reference channel which is standard of deviation upper limit alarm(DV.Hi) or deviation lower limit alarm(DV.Lo).

If display value of relevant channel is lower than the display value of set reference channel, deviation upper limit alarm or deviation lower limit alarm turns ON.

This parameter is activated when Alarm Type(Alarm operation mode) is set as deviation upper limit alarm(DV.Hi) or deviation lower limit alarm(DV.Lo).

- Setting range: None / CH -S UI -
- Factory default: -

8.2.5 Alarm□ Option(Alarm□ option)



Set alarm output by alarm operation.

Set value		Description
None	Standard alarm	If it is an alarm condition, alarm output is ON. If it is a clear alarm condition, alarm output is OFF.
Latch ^{※1}	Alarm latch	If it is an alarm condition, alarm output is ON and maintains ON status. (Alarm output HOLD)
StBy ^{※2}	Standby sequence	First alarm condition is ignored and from second alarm condition, standard alarm operates.
La+St	Alarm latch and standby sequence	If it is an alarm condition, it operates both alarm latch and standby sequence. When power is supplied and it is an alarm condition, this first alarm condition is ignored and from the second alarm condition, alarm latch operates.

※1. In case Alarm□ Type (Alarm□ operation mode) is SBA(Input break alarm) or P.END(No recording paper alarm), you can only select Latch(Alarm latch).

※2. Condition of re-applied standby sequence: Power ON, changing the set alarm temperature, forced alarm reset.

- Setting range: None↔Latch↔StBy↔La+St
- Factory default: None



Note

In case for input break alarm(SBA), no recording paper alarm (P.END), standby sequence, or alarm latch and standby sequence option does not operates and you cannot set it.

In case of alarm by alarm latch, to reset alarm output, press  key for 3 sec at not alarm condition, use alarm reset function by digital input, or turn OFF the power and ON.

To reset alarm output by digital input, DI-□ Type(Select digital input□) from DIGITAL INPUT SETUP is should be set as 'Alarm Reset'.

Reset alarm output is available only when alarm option is set as alarm latch or alarm latch and standby sequence, or when current temperature is out of alarm operation range. At the next alarm output ON, alarm output operates normally.



Ex.

Alarm□ Type(Alarm□ operation mode): PV.Lo (Absolute value lower limit alarm)

Alarm□ Value(Alarm□ set value): 90

Alarm□ Hysteresis(Alarm□ hysteresis): 5

Alarm□ Option(Alarm□ option): StBy(Standby sequence)

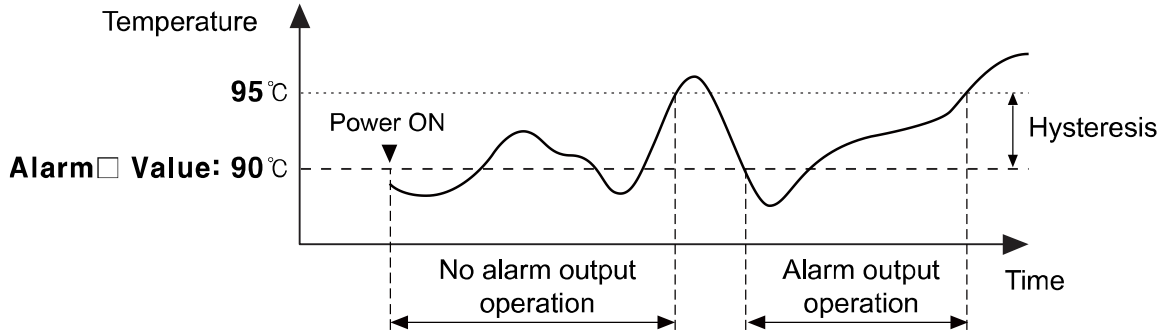

When power is ON, it is alarm condition and it is ignored. From second alarm conditions, it operates as standard alarm.

8.2.6 Alarm Value(Alarm set value)

ALARM SETUP CH1-S1UI-1																																																																						
<NAME>						<VALUE>																																																																
Select UI Card						CH1-S1UI-1																																																																
Alarm Set Copy						CH Select																																																																
Alarm1 Type						PV.Hi																																																																
Alarm1 Ref CH						--																																																																
Alarm1 Option						None																																																																
Alarm1 Value						1350.0																																																																
<table border="1"> <tr> <td></td> <td>A</td> <td>B</td> <td>C</td> <td>D</td> <td>E</td> <td>F</td> <td>G</td> <td>+</td> <td>1</td> <td>2</td> <td>3</td> </tr> <tr> <td rowspan="4">Keyboard</td> <td>H</td> <td>I</td> <td>J</td> <td>K</td> <td>L</td> <td>M</td> <td>N</td> <td>-</td> <td>4</td> <td>5</td> <td>6</td> </tr> <tr> <td>O</td> <td>P</td> <td>Q</td> <td>R</td> <td>S</td> <td>T</td> <td>U</td> <td>*</td> <td>7</td> <td>8</td> <td>9</td> </tr> <tr> <td>V</td> <td>W</td> <td>X</td> <td>Y</td> <td>Z</td> <td>Space</td> <td>/</td> <td>0</td> <td>.</td> <td>-</td> <td></td> </tr> <tr> <td colspan="11">135</td> <td>A a *</td> </tr> </table>														A	B	C	D	E	F	G	+	1	2	3	Keyboard	H	I	J	K	L	M	N	-	4	5	6	O	P	Q	R	S	T	U	*	7	8	9	V	W	X	Y	Z	Space	/	0	.	-		135											A a *
	A	B	C	D	E	F	G	+	1	2	3																																																											
Keyboard	H	I	J	K	L	M	N	-	4	5	6																																																											
	O	P	Q	R	S	T	U	*	7	8	9																																																											
	V	W	X	Y	Z	Space	/	0	.	-																																																												
	135											A a *																																																										
<table border="1"> <tr> <td>Fn</td> <td><</td> <td>></td> <td>^</td> <td>v</td> <td>ENTER</td> <td>Fn*</td> <td><</td> <td>></td> <td>^</td> <td>v</td> <td>ENTER</td> </tr> </table>													Fn	<	>	^	v	ENTER	Fn*	<	>	^	v	ENTER																																														
Fn	<	>	^	v	ENTER	Fn*	<	>	^	v	ENTER																																																											

Set alarm set value based on alarm output operation mode, it executes alarm operation.

- Setting range: Using set input from Input Type(Input specification)/within display range
- Factory default: Alarm1 value: 1350.0, Alarm2 Value to Alarm4 Value: -

8.2.7 Alarm Hysteresis(Alarm hysteresis)

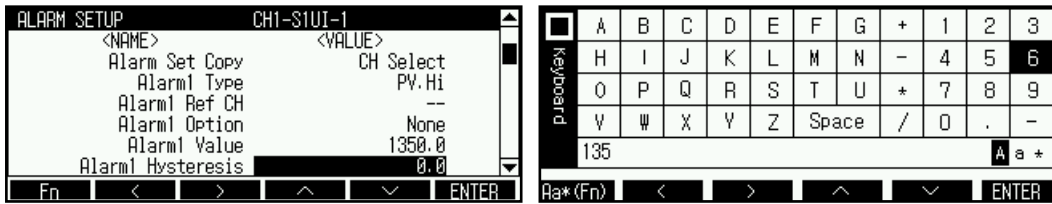

Set the interval between alarm output ON and OFF.

If PV is over or below alarm output SV, output turns ON and it sets OFF time by hysteresis settings.

When input value is changed near SV, alarm output is often. Set hysteresis and it can be prevent from often alarm output.

- Setting range: 0.0 to 9999.9 (Decimal point position is different by the set decimal point position of input.)
- Factory default: 0.0



The below graph is when Alarm Type(Alarm operation mode) is set as absolute value upper limit alarm, Alarm Value(Alarm set value) is set as 200, and Alarm Hysteresis(Alarm hysteresis) is set as 10.

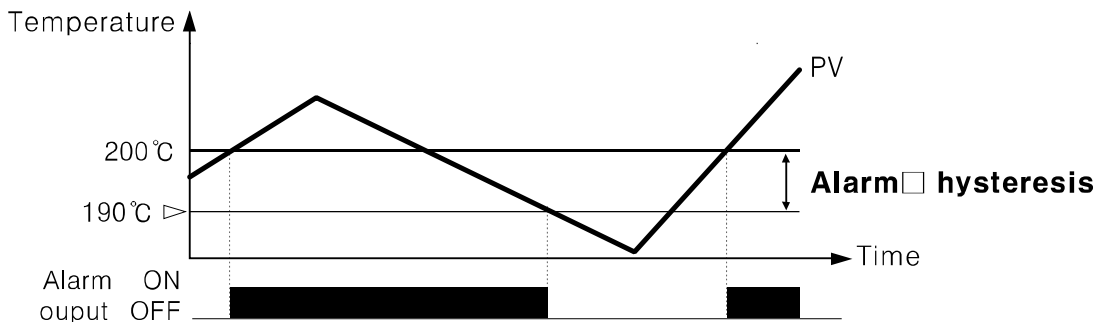

8.2.8 Alarm ON/OFF Delay (Alarm ON/OFF output delay time)



Set delay time (unit: sec.) to prevent alarm malfunction by wrong input from external disturbance and noise.

Item	Description
Alarm On Delay	Even after standby the set time when alarm ON condition (alarm ON channel flashes on screen), if it is still alarm condition, alarm output turns ON. (Alarm ON channel flashes on screen).
Alarm OFF Delay	Even after standby the set time when alarm reset condition (alarm ON channel display is hold), if it is still alarm reset condition, alarm output turns OFF. (Alarm ON channel resets the display.)

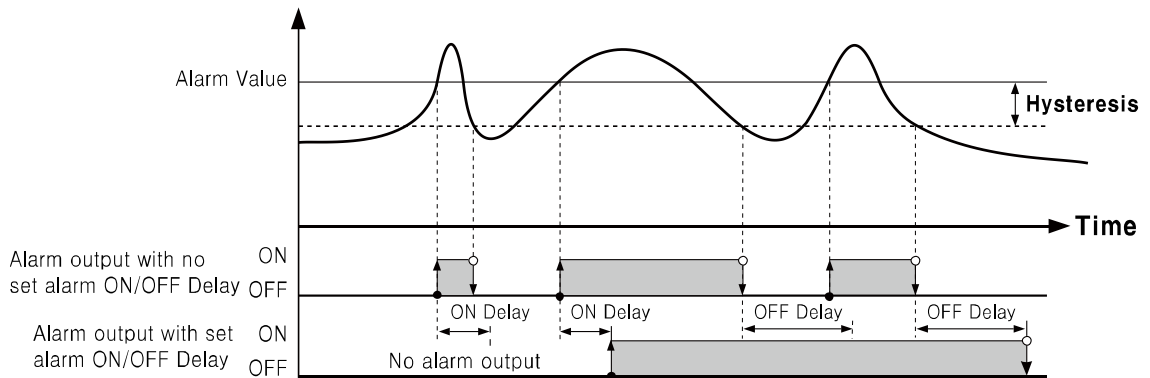

- Setting range: 0 to 3600
- Factory default: 0s

8.2.9 Alarm Alarm No(Alarm output alarm number)

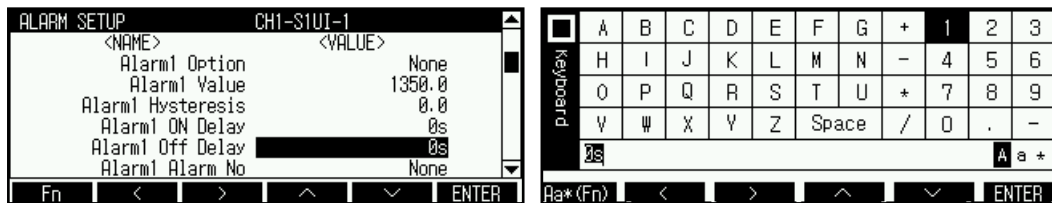

Select alarm output number to output alarm in alarm ON.

If the setting as 'None' and when alarm operation occurs, it displays alarm on the screen and records alarm operation mode, and alarm occurrence time on recording paper, but it does not output alarm.

There are two alarm output types; Transistor and Relay output. KRN recognizes automatically the connected type and displays it.

In this parameter, transistor output type is displayed as TR-SAL-(), and Relay output type is displayed as RELAY-SAL-().

These parameter's meaning is as below.

S: The number of module connected SLOT,

AL-: Alarm output channel number,

Number in parenthesis '()': the number of designated alarm as output in the specified channel

- Setting range: None / -SAO-()
- Factory default: None

8.2.10 Select Alarm Card(Select alarm output card)



Select alarm output card(KRN-AR4, KRN-AT6) to set output type (Normally Open, Normally Closed) of alarm output. In front of output card name, relay or transistor abbreviation is displayed for easy to know connected module type when selecting output card.

8.2.11 Alarm-□ Status(Relay and transistor output method)



Set alarm output method (Normally Open, Normally Closed) of each alarm output channel from the set alarm output card in Select Alarm Card (Select alarm output card).

You can use alarm output as relay output or transistor output by inserting the desired alarm output card(Relay output: KRN-AR4, transistor output: KRN-AT6).

Set value	Description		Alarm occurrence	Alarm output	
				Relay	Transistor
N.O.	Normally Open	In normal status it is open. If alarm occurs, it is closed.	OFF	Contact Open	Transistor OFF
			ON	Contact Close	Transistor ON
N.C.	Normally Closed	In normal status it is closed. If alarm occurs, it is open.	OFF	Contact Close	Transistor ON
			ON	Contact Open	Transistor OFF

This function displays as Alarm-□ Status and it is connected relay or transistor Type's output card information. One card for relay has 4 outputs(Alarm-1 Status to Alarm-4 Status), for transistor has 6 outputs (Alarm-1 Status to Alarm 6 Status).

Relay output card(KRN-AR4) is connectable up to 3, and transistor output card (KRN-AT6) is connectable up to 2 at Slot7 to 10.

Alarm output turns ON or OFF by total 4 alarm conditions and relay, transistor output are able to output by max. 48 alarm conditions. However, every relay output and transistor output condition is OR operation (Among several alarm conditions connected one alarm output, even one alarm condition is met, output must turn ON.).

- Setting range: N.O. ↔ N.C.
- Factory default: N.O.



Note

Relay and transistor type output is basically fixed as Normally Opened method and H/W when power is ON.

Therefore, KRN100 takes booting time max. 20sec and maintains Normally open status. In case of RUN mode after booting, it maintains use-defined output type; Normally Open or Normally Closed.

8.3 DIGITAL INPUT SETUP(Digital input setting)

You can set executing function by digital input card, operation stauts, etc.

Move to DIGITAL INPUT SETUP with ,  keys, press  key to enter DIGITAL INPUT SETUP.

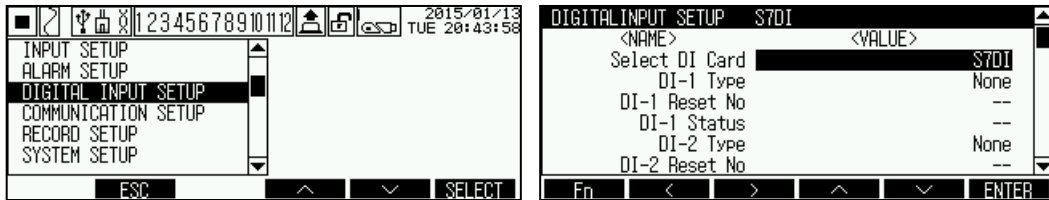

Parameter list

Parameter	Setting range	Factory default
Select DI Card (Select digital input card)	S7DI ↔ S8DI ↔ S9DI ↔ S10DI	Automatically set
DI-□ Type (Select digital input □)	None ↔ Run ↔ Memo ↔ ListOut ↔ Speed ↔ Alarm Reset	None
DI-□ Reset No (Reset alarm number)	None ↔ ALL ↔ S□AL-□	-
DI-□ Status (Operation status)	Edge ↔ Level	-

※Shaded parameters are affected by set value of other parameters. Please refer to specific descriptions of each parameter.

8.3.1 Select DI Card (Select digital input card)

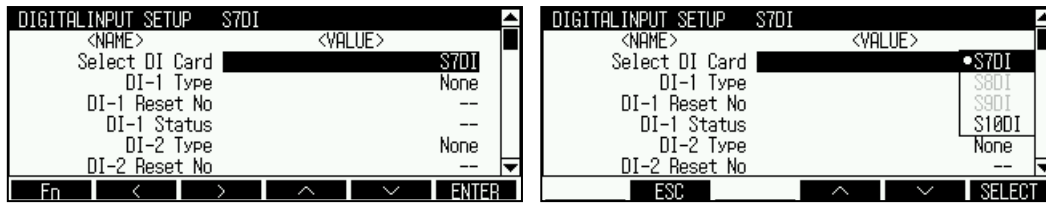

Select digital input card (KRN-DI6) to be selected.

KRN100 searches connected digital input card automatically on slot and recognizes the number of digital input card as soon as power is ON.

Channel name is as below.

- Setting range: S7DI ↔ S8DI ↔ S9DI ↔ S10DI
- Factory default: Automatically set



Ex.

S9DI: This means connected digital input card on 9th slot

8.3.2 DI-□ Type (Select digital input □)

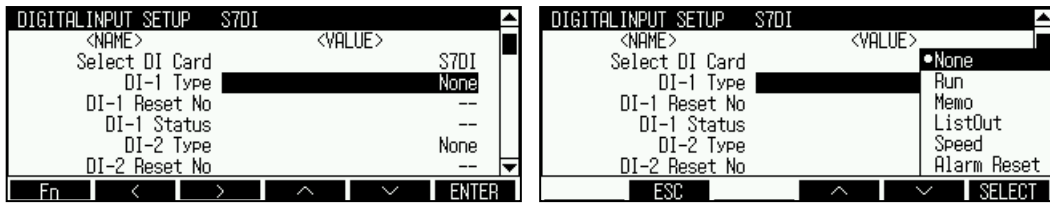

Select digital input.

Mode	Operation name	Operation description	Level		Edge	
			Open	Short	Min. signal input ^{※1}	Icon ^{※2}
None	-	No function	-	-	-	
Run ^{※3}	Start/Stop recording	Starts/Stops recording on recording paper.	STOP	RUN	STOP↔RUN	
Memo	Digital memo	Executes digital memo function	-	-	Memo	
ListOut	List output	Outputs parameter set information	-	-	ListOut	
Speed	Record speed (graph) and period (digital)	Executes to record with set option record speed and period (Option speed, period).	Standard	Option	Standard ↔ Option	
Alarm Reset	Forced alarm reset	In case alarm option is alarm latch, alarm output is reset by force.	-	-	Alarm Reset	

※ 1. At every min. signal input width (over 0.3 sec.), it executes the function repeatedly.

※ 2. The appropriate icon is displays on the screen, digital input function is operating.

※ 3. When digital input operation status is set as Level in RUN mode, you cannot operate starting/stopping recording with front key. (If it set as 'Edge', front key operates starting/stopping recording.)

When reservation record(Reservation) is set and now is reservation recording state, digital input function is not available as RUN mode. This is available in record stop state by reservation record.

- Setting range: None ↔ Run ↔ Memo ↔ ListOut ↔ Speed ↔ Alarm Reset
- Factory default: None

8.3.3 DI-□ Reset No (Reset alarm number)

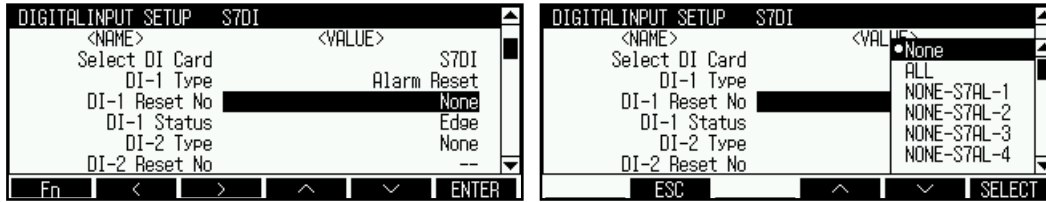

Select alarm to reset at digital input.

Set DI-□ Type(Select digital input□) as forced alarm reset (Alarm Reset), it is activated.

Alarm reset is available when alarm option is Alarm latch or Alarm latch and standby sequence and it is not alarm condition.

- Setting range: None↔ALL↔ S□-AL-□
- Factory default: -

8.3.4 DI-□ Status (Operation status)



Designate operation status of set digital input.

Set value	Description
Edge	When digital input is input over 0.3 sec., the set function operates. If digital input is re-input the reverse function operates.
Level	When digital input is short over 0.3 sec., the set function operates. If digital input is open over 0.3 sec., the operation is stop.

- Setting range: Edge ↔ Level(Please refer to '8.3.2 DI-□ Type (Select digital input □)').)
- Factory default: -



Note

In digital input setting, when DI-□ Type is set as Run or Seed, and DI-□ Status is set as Edge, overlap setting is available. But DI-□ Status is set as Level, overlap setting is not available.

If even one Level is set, DI-□ Status's overlap setting to Level or setting to Edge is not available.

In case DI-□ Status(operation status) is Edge: You can execute to start/stop recording with front key.

In case DI-□ Status(operation status) is Level: You cannot execute to start/stop recording with front key.

8.4 COMMUNICATION SETUP (Communication setting)

Set the related parameters with communication output card(KRN-COM).

You can only check the item of COMMUNICATION SETUP by communication but cannot change the set.

This parameter is for setting and monitoring parameters from external upper system (PC and graph panel, etc) or transmitting the data to external devices by RS485, Ethernet, or USB Device communication

It is recommended to use our dedicated software program DAQMaster for monitoring. If you want to develop monitoring program not using our DAQMaster program or to use the related Modbus program, please refer to user manual for communication.

Visit our homepage (www.autonics.com) to download DAQMaster program, and user manual for communication.

Move to COMMUNICATION SETUP with ,  keys, press  key to enter COMMUNICATION SETUP.



Parameter list

Parameter	Setting range	Factory default
Modbus Address (Communication address)	1 to 127	1
RS485 Port (Use RS485 communication)	Enable ↔ Disable	Enable
Baud Rate (Baud rate)	2400 ↔ 4800 ↔ 9600 ↔ 19200 ↔ 38400	9600
Parity Bit (Communication parity bit)	None ↔ Odd ↔ Even	None
Stop Bit (Communication stop bit)	1 ↔ 2	2
Termination Set (Terminating resistance)	Disable ↔ Enable	Disable
Response Wait Time (Communication response wait time)	5 to 99ms	20ms
Protocol (Communication protocol)	Modbus RTU	Modbus RTU
RS485 Com Write (RS485 communication write)	Enable ↔ Disable	Enable
Ethernet Port (Use Ethernet communication)	Enable ↔ Disable	Disable
IP Address (IP address)	0.0.0.0 to 255.255.255.255	-
Subnet Mask (Subnet Mask)	0.0.0.0 to 255.255.255.255	-
Default Gateway (Default gateway)	0.0.0.0 to 255.255.255.255	-
Ethernet Com Write (Ethernet communication write)	Enable ↔ Disable	-
USB Device Port (Use USB communication)	Enable ↔ Disable	Enable
USB Com Write (USB communication write)	Enable ↔ Disable	Enable



Note

KRN100 does not support RS485 port, Ethernet port at the same time for preventing system overload. If you change one as 'Enable', the other is changed 'Disable' automatically. In case USB Device, it is able to set 'Enable', 'Disable' regardless of RS485 or Ethernet setting.

- Interface

Item	RS485	Ethernet	USB Device
Application standard	Compliance with EIA RS485	-	Compliance with USB V2.0
Max. connection	31 units (address: 1 to 127)	1 units (number of occupations per a unit)	1 units
Communication distance ^{※1}	Max. 1Km (Below 9600bps)	Single cable within 100m (Recommended over CAT5E)	Single cable within 1.5m
Communication method	Half Duplex	Full Duplex	-
Communication synchronization method	Asynchronous	Asynchronous	Asynchronous
Communication speed	2400/4800/9600/19200 /38400bps	10/100Mbps	12Mbps(Full Speed)
Communication response wait time	5to99 ms	-	-
Start Bit	1 bit(fixed)	-	-
Data Bit	8 bit(fixed)	-	-
Parity Bit	None, Odd, Even	-	-
Stop Bit	1, 2 bit	-	-
Protocol	Modbus RTU	Modbus TCP	Modbus RTU

※1. When connecting through the network such as network hub (HUB) and gateway, etc, there is no distance limit, but it is recommended to use min. network.

Please use communication cables which is satisfied the below conditions.

RS485 communication	Shield Twist Pair over AWG24, characteristic impedance 100Ω, capacity component 50pF/m cable length max. 1km
Ethernet communication	Over CAT5E, cable max. length: 100m
USB Device communication	Single cable built-in ferrite core within 1.5m

**Note**

USB Device communication may cause recognition error by external noise and environment during connecting PC. If there is error, please re-connect this.
Please use USB Device as for setting.

During communication, if you changing the communication settings, it may cause communication error.

**Note**

RS485 communication port of KRN100 is connected for 3 A, B, SG terminals.
SG terminal is connectable with shield or SG of converter, and you do not need to connect SG terminal.

To remove noise during RS485 communication, use shield cable. There are three methods for shield processing.

1	Connects shield cable only for SG terminal of communication module.	When electric potential occurs between computer and recorder grounded, connect shield cable for SG terminal of recorder to minimize noise effect not to flow current on shield cable. (It is used generally.)
2	Connects shield for both SG terminal of communication module and the grounding of computer.	When electric potential does not occur between computer and recorder grounded, it is effective to minimize noise influence.
3	Connects shield for one of SG terminal of communication module or the grounding of computer.	It can minimize noise effect in case of connecting non-polarity condenser in series.

It is recommended to use SCM-US 48I(USB/RS485 converter) or SCM-38I(RS232C/RS485 converter) for RS485 communication between PC and KRN100.

If using the non-grounded converter between FG and SG, it may cause damage to KRN100 and communication error by electric potential of between ground during long-distance communication.

For using terminating resistance, turn ON only terminal resistance of recorder on end of connected communication line (Enables to set using terminating resistance in communication set function), and also turn ON terminal resistance of connected communication to PC.

8.4.1 Modbus Address (Communication address)

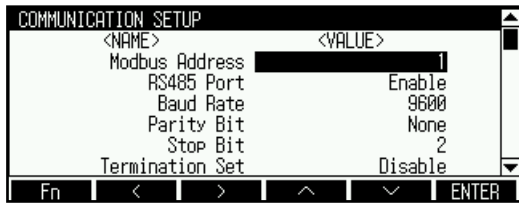

Designate communication address.

The designated communication address is able to apply to RS485, USB Device, also Ethernet communication. However, duplicated communication address setting in same communication line does not allow.

- Setting range: 1 to 127
- Factory default: 1

8.4.2 RS485 Port (Use RS485 communication)

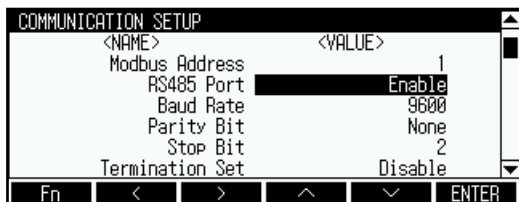

Set whether using RS485 communication.

If you set RS485 Port's set value as 'Enable', Ethernet Port's set value is changed 'Disable' automatically.

- Setting range: Enable ↔ Disable
- Factory default: Enable

8.4.3 Baud Rate (Baud rate)

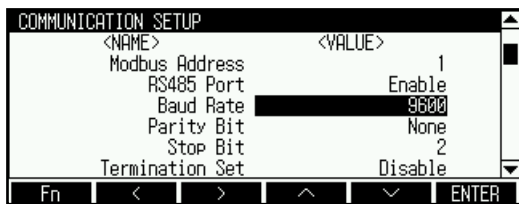

Designate baud rated.

- Setting range: 2400 ↔ 4800 ↔ 9600 ↔ 19200 ↔ 38400 (unit: bps)
- Factory default: 9600

8.4.4 Parity Bit (Communication parity bit)

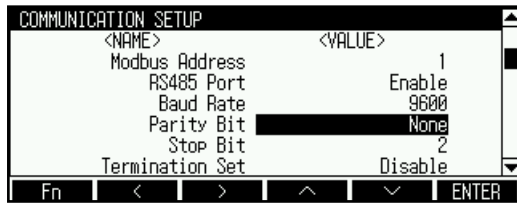

Designate communication parity bit.

- Setting range: None ↔ Odd ↔ Even
- Factory default: None

8.4.5 Stop Bit(Communication stop bit)

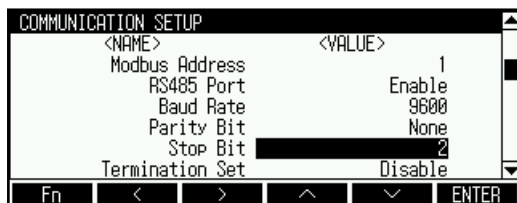

Designate communication stop bit.

- Setting range: 1 ↔ 2 (unit: bps)
- Factory default: 2

8.4.6 Termination Set (Terminating resistance)



Designate whether using terminating resistance.

You do not need to external terminating resistance (120Ω) because KRN100 is able to use terminating resistance by parameter setting.

- Setting range: Enable ↔ Disable
- Factory default: Disable

8.4.7 Response Wait Time (Communication response wait time)

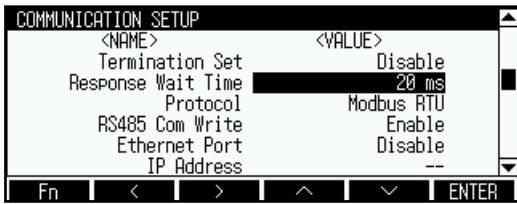

To prevent possible error due to communicating with low speed Master (PC, PLC, etc), set communication response wait time.

If you set too short communication response wait time, communication error may occur in Master.

- Setting range: 5 to 99 (unit: ms)
- Factory default: 20ms

8.4.8 Protocol (Communication protocol)



It supports Modbus RTU(Remote Terminal Uint) as communication protocol.

(Data Length: 8bit, Data interval: 24bits or less,Error Detection: CRC-16)

- Setting range: Modbus RTU
- Factory default: Modbus RTU

8.4.9 RS485 Com Write (RS485 communication write)



Set whether changing the set value of KRN100 parameter by RS485 communication.

To read the set value of each parameter is available regardless of the communication write enable/disable setting.

- Setting range : Enable ↔ Disable
- Factory default : Enable

8.4.10 Ethernet Port (Use Ethernet communication)

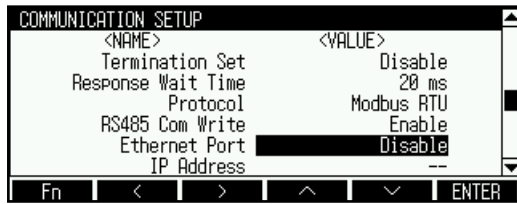

Set whether using Ethernet communication.

If you set Ethernet Port as 'Enable', RS485 Port is changed as 'Disable' automatically.

- Setting range: Enable ↔ Disable
- Factory default: Disable



Note

You can monitor or set parameter KRN100 with DAQMaster or the related Modbus program (Modbus Poll, etc). For more information, refer to 'KRN100 user manual for communication.'

[Modbus TCP communication]

The following is based on Windows XP.

- 1st First of all connect Ethernet slot of KRN-100 communication output card (KRN-COM) and LAN slot of PC with LAN cable.

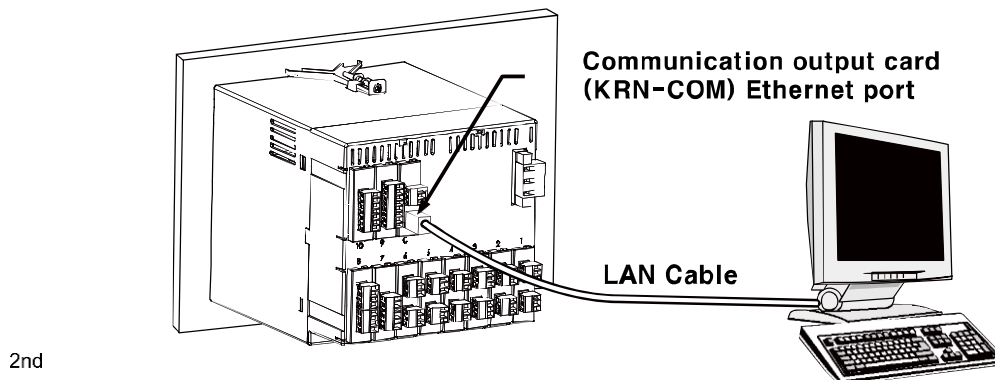

2nd

Execute Start > Run to check IP address of PC.



Enter "ipconfig" at "Open" in Run dialog box and you can check IP address of PC.

3rd

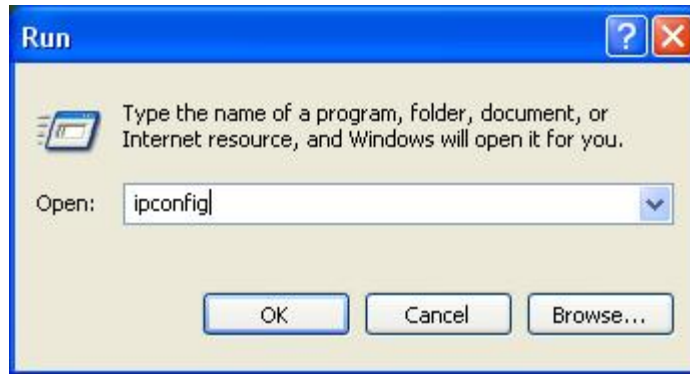

4th

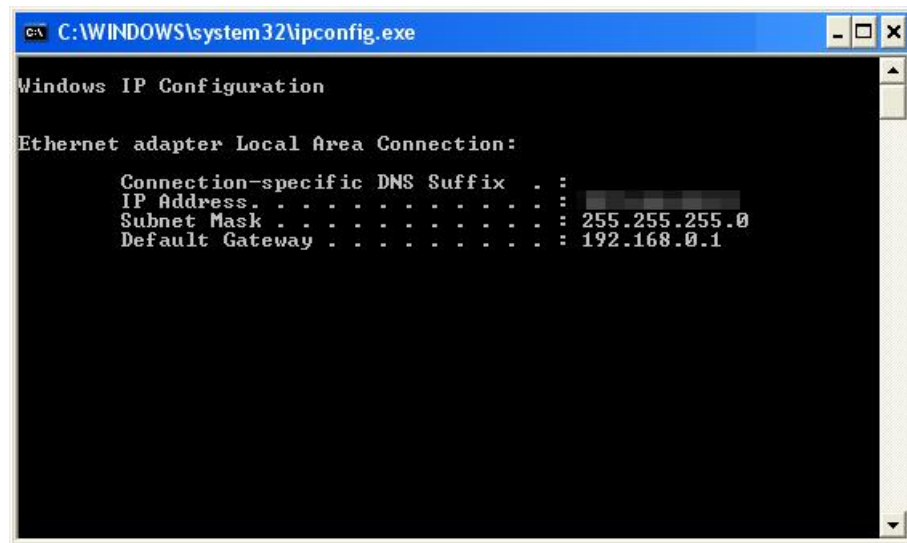

Set KRN100 Ethernet Port(Use Ethernet communication) as 'Enable' at COMMUNICATION SETUP (Communication setting) of KRN100. Set IP Address(IP address) as installation environment.

	PC	KRN100
IP Address	192.168.1.1	192.168.1.2
Subnet Mask	255.255.255.0	
Default Gateway	192.168.1.1	

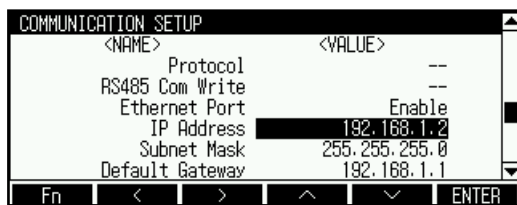

IP address set for Modbus TCP communication is complete.

8.4.11 IP Address (IP address)

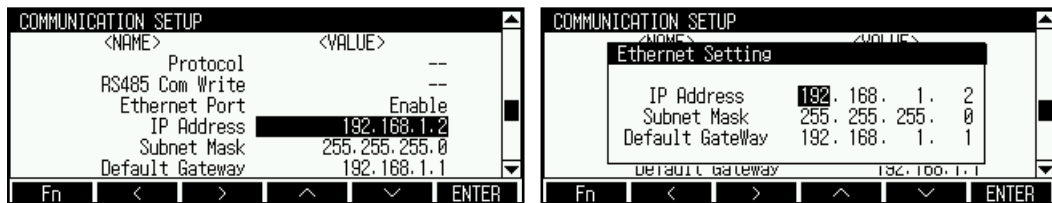

Designate used IP address to identify the device on the network.

If there is same IP address on the network, communication does not operate by IP conflict.

- Setting range: 0.0.0.0 to 255.255.255.255
- Factory default: -

8.4.12 Subnet Mask (Subnet Mask)

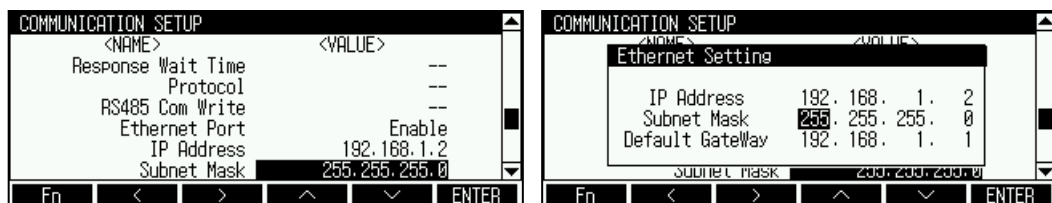

To recognize network ID part and host ID part of IP address, set 32 bit address allowing to IP packet receiver.

To enter correct set value, whenever press  ,  keys, it displays inputable subnet mask value is displayed.

- Setting range: 0.0.0.0 to 255.255.255.255
- Factory default: -

8.4.13 Default Gateway (Default gateway)

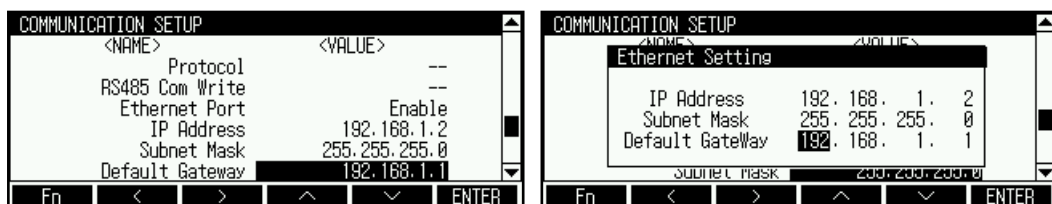

Designate IP address to connect IP router directly.

- Setting range: 0.0.0.0 to 255.255.255.255
- Factory default: -

8.4.14 Ethernet Com Write (Ethernet communication write)

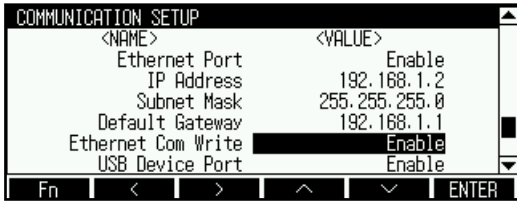

Set whether changing the set value of KRN100 parameter by Ethernet communication.

To read the set value of each parameter is available regardless of the communication write enable/disable setting.

- Setting range: Enable ↔ Disable
- Factory default: -

8.4.15 USB Device Port (Use USB communication)



Set whether using USBcommunication.

USB communication is available regardless of RS485 Port or Ethernet Port setting.

- Setting range: Enable ↔ Disable
- Factory default: Enable

8.4.16 USB Com Write (USB communication write)



Set whether changing the set value of KRN100 parameter by USB communication.



To read the set value of each parameter is available regardless of the communication write enable/disable setting.

- Setting range: Enable ↔ Disable
- Factory default: Enable

8.5 RECORD SETUP (Record setting)

You can set record mode, record speed, record language, and digital memo, etc.

Depending on record mode (Digital, Graph), below parameters are changed.

Move to RECORD SETUP with   keys, press  key to enter RECORD SETUP.



Parameter list

Parameter	Setting range	Factory default
Record Mode (Recode mode)	Graph ↔ Digital	Graph
Digital Print type(1 line record channel during numeric recording)	OneCH ↔ TwoCH	TwoCH
Standard Speed (Standard record speed)	10 ↔ 20 ↔ 40 ↔ 60 ↔ 120 ↔ 240mm/h	20mm/h
Option Speed (Option record speed)	10 ↔ 20 ↔ 40 ↔ 60 ↔ 120 ↔ 240mm/h	20mm/h
Memo Period (Digital memo period)	Refer to detail descriptions.	2hour
Divide Zone (Record zone division)	None, 2 to 12	None
Standard Period (Standard record period)	00m01s to 99m99s	-
Option Period (Option record period)	00m01s to 99m99s	-
Listing Language (Language for list output)	Korea ↔ English	English
Alarm Speed (Alarm record speed)	10 ↔ 20 ↔ 40 ↔ 60 ↔ 120 ↔ 240mm/h	20mm/h
Power On Status (Record status when power ON)	Hold ↔ Run ↔ Stop	Hold
Run Status (List printing at start recording)	OFF ↔ ON	OFF
List Out Option (List record option)	Standard ↔ Option	Standard
Zone Dot Line Distance (Dot line for zone division)	None to 8.0mm	4.0mm
CH Print Distance (Record interval for each channel graph)	None to 100.0mm	20.0mm
Start Line Print (Start line when starting record)	ON ↔ OFF	ON
Range Print Time (Input range record period)	Disable, 1to 24 hour	Disable
Pen1 (Violet) ON Time (Ink cartridge point delay time)	1 to 25	13
Pen2 (Red) ON Time (Ink cartridge point delay time)	1 to 25	13
Pen3 (Black) ON Time (Ink cartridge point delay time)	1 to 25	13
Pen4 (Green) ON Time (Ink cartridge point delay time)	1 to 25	13
Pen5 (Blue) ON Time (Ink cartridge point delay time)	1 to 25	13
Pen6 (Brown) ON Time (Ink cartridge point delay time)	1 to 25	13

※ Shaded parameters are affected by set value of other parameters. Please refer to specific descriptions of each parameter.

8.5.1 Record Mode (Recode mode)

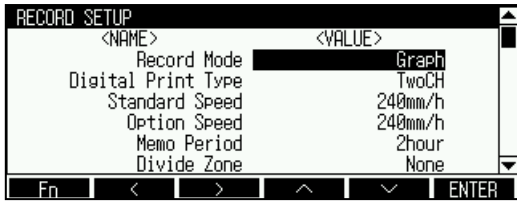

Set record mode to record display value on recording paper. KRN100 supports Graph, and Digital record modes.

(1) Graph

Records display value as graph type on recording paper.

It records current time (hh:mm:ss), display value by channel in set Memo Period(Digital memo record period)

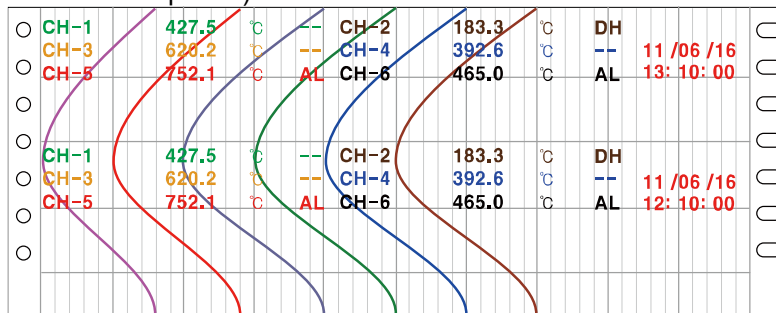

(2) Digital

Records display value as numeric on recording paper.

It records current time (hh:mm:ss), display value by channel in set Standard Period (Print/Record period) and also records current date (Year-Month-Day) and time in every 00:00:00.

You can record digital memo manually by front key (press key for 3 sec), or digital input terminal.

----- CHANGE DAY 11 / 06 / 16 00 : 00 : 00(S) -----					
CH-1	125.5	°C	CH-2	203.3	°C
CH-3	320.2	°C	CH-4	512.6	°C
CH-5	452.1	°C	CH-6	825.0	°C
----- CHANGE DAY 11 / 06 / 15 00 : 00 : 00(S) -----					
CH-1	125.5	°C	CH-2	203.3	°C
CH-3	320.2	°C	CH-4	512.6	°C
CH-5	452.1	°C	CH-6	825.0	°C

Records every 00:00:00. (S) is summer time.

Digital memo (Manual)

- Setting range: Graph ↔ Digital
- Factory default: Graph

8.5.2 Digital Print type(1 line record channel during numeric recording)

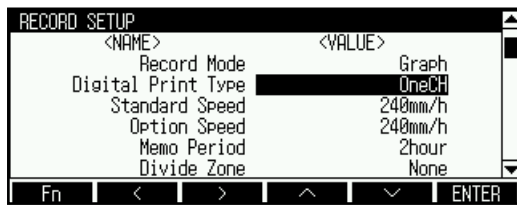

Designate the number of channels to be printed when recording display value on recording paper.

It prints channel information between Graph and Digital record mode.

- Setting range: OneCH ↔ TwoCH
- Factory default: TwoCH



(1) TwoCH

It records 2 channels in one line and records occurring alarm as abbreviation. In case of multi alarms, it records as 'AL'.

Print form is as below.

Tag Name	PV	Unit	Unit	PV	Unit	DATE TIME
CH-1 CH-3 CH-5	125.5 320.2 452.1	°C °C °C	-- PL --	CH-2 CH-4 CH-6	203.3 512.6 825.0	-- AL --
			Alarm/Error			Alarm/Error

(2) OneCH

It records 2 channels in one line and records occurring alarm as abbreviation. Not as TwoCH, it also records one channel's error message and occurring alarms in 4 alarms.

Print form is as below.

Tag Name	PV	Unit	Error	Alarm1	Alarm2	Alarm3	Alarm4	DATE TIME
CH-1 CH-2 CH-3 CH-4 CH-5 CH-6	125.5 850.1 325.5 524.3 348.1 152.2	°C °C °C °C °C °C	LL -- -- HH -- --	-- -- -- PH -- --	SB -- -- -- -- --	-- -- -- -- -- --	DH -- -- -- -- --	11 / 06 / 16 11: 00: 00

For the information about alarm abbreviations, please refer to '8.2.3 Alarm □ Type(Alarm □ operation mode)'.

For the information about error abbreviations, please refer to '11.1 Error message'.

8.5.3 Standard Speed (Standard record speed)

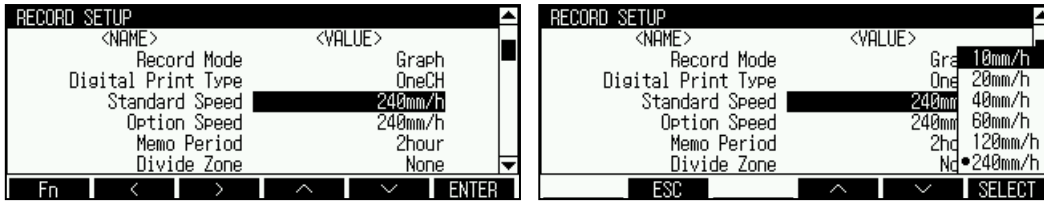

Designate record speed on recording paper.

Recorder speed is indicated as feed length of recording paper per an hour (mm/h) and it is activated only when Record Mode(Record mode) is set as 'Graph(Graph)'.

- Setting range: 10 ↔ 20 ↔ 40 ↔ 60 ↔ 120 ↔ 240mm/h
- Factory default: 20mm/h

8.5.4 Option Speed (Option record speed)

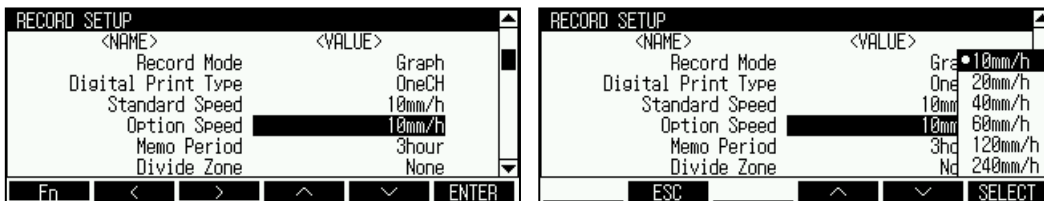

Designate option record speed.

Recorder speed is indicated as feed length of recording paper per an hour (mm/h) and it is activated only when Record Mode(Record mode) is set as 'Graph(Graph)'.

After setting DI-□ Type(Select digital input□) as 'Speed', select either Standard Speed(standard record speed) ↔ Option Speed(option record speed) by digital input.

When changing the set value of Standard Speed(Standard record speed), the set value of Option Speed(Option record speed) is also changed as same as the set value of Standard Speed. (Option Speed should not be lower than Standard Speed.)

- Setting range: 10 ↔ 20 ↔ 40 ↔ 60 ↔ 120 ↔ 240 mm/h
- Factory default: 20mm/h

8.5.5 Memo Period (Digital memo period)



Designate record period (unit: min) for digital memo(current time, current value by channel).

Digital memo time is recorded at right time. You can record digital memo manually by pressing key for 3 sec or using digital input terminal (DI-2).

- Setting range: Recording record speed and record channel, setting range of digital memo period is limited.
- Factory default: 2hour



Ex.

If digital memo period is set as 60 min. and record start time is '09:20', first record time is '10:00', not '10:20'.

Digital record time is '10:00 → 11:00 → 12:00 → 13:00 → record end time'.

If digital memo period is set as 10 min, and record start time is '09:23', first record time is '09:30', not '09:33'.

Digital record time is '09:30 → 09:40 → 09:50 → 10:00 → record end time'.



Note

Depending on record speed and the number of record channels, memo period setting time is limited. (Record speed unit: mm/h)

Digital memo period setting time when record channel is 1 to 2CH												
Record speed	1 min	5 min	10 min	15 min	30 min	1 hour	2 hour	3 hour	4 hour	8 hour	16 hour	24 hour
10			X	X								
20		X	X									
40	X											
60					○	○						
120		○	○									
240	○											

Digital memo period setting time when record channel is 3 to 4CH												
Record speed	1 min	5 min	10 min	15 min	30 min	1 hour	2 hour	3 hour	4 hour	8 hour	16 hour	24 hour
10				X	X							
20		X	X									
40	X											
60					○	○						
120		○	○									
240	○											

Digital memo period setting time when record channel is 5 to 6CH												
Record speed	1 min	5 min	10 min	15 min	30 min	1 hour	2 hour	3 hour	4 hour	8 hour	16 hour	24 hour
10					X	X						
20				X								
40		X	X									
60	X											
120												
240												

Digital memo period setting time when record channel is 7 to 8CH												
Record speed	1 min	5 min	10 min	15 min	30 min	1 hour	2 hour	3 hour	4 hour	8 hour	16 hour	24 hour
10					X	X						
20												
40		X	X	X								
60	X											
120												
240												

Digital memo period setting time when record channel is 9 to 10CH												
Record speed	1 min	5 min	10 min	15 min	30 min	1 hour	2 hour	3 hour	4 hour	8 hour	16 hour	24 hour
10					X	X						
20												
40		X	X	X								
60	X											
120												
240												

Digital memo period setting time when record channel is 11 to 12CH												
Record speed	1 min	5 min	10 min	15 min	30 min	1 hour	2 hour	3 hour	4 hour	8 hour	16 hour	24 hour
10					X	X	X					
20												
40			X	X								
60	X	X										
120												
240												

8.5.6 Divide Zone (Record zone division)

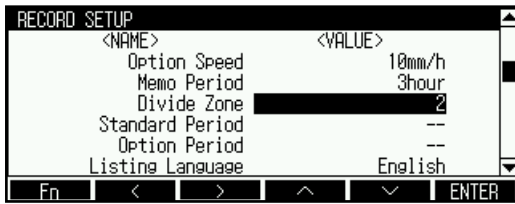

Divides record zone for measuring value by channel.

It divides equally max. 12 zones as equal value. User needs to set record zone by channel in Record Zone setting at Input Setup.

It is easy to check measuring value due not to duplicated record zone with divided record zone by channel which is set in Record Zone setting at Input Setup.

If there is too many division for record zone, record value check accuracy is low.

- Setting range: None, 2 to 12
- Factory default: None



Ex.

Set value of record zone division: None

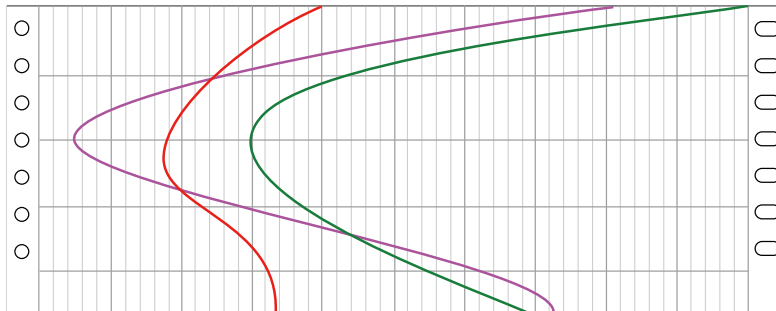

Set value of record zone division : 5

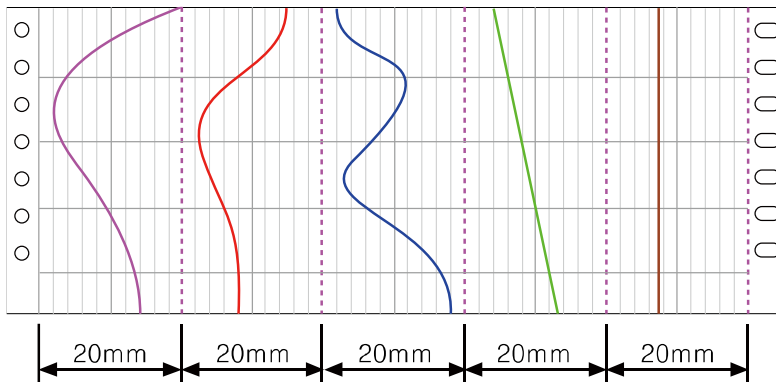

8.5.7 Standard Period (Standard record period)

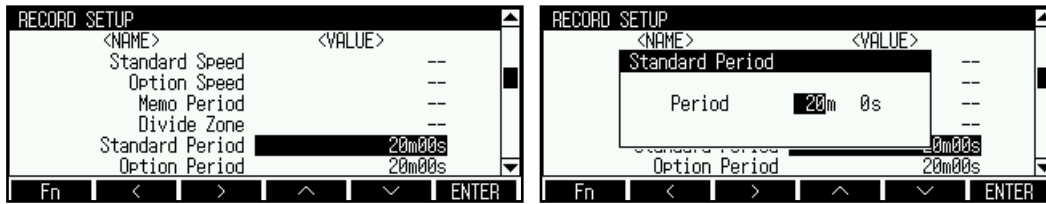

Set record period to record current time, display value by channel as digital number on recording paper.

It is activated when Record Mode(Record mode) is Digital.

- Setting range: 00m 01s to 99m 59s (Depending on the number of recording channel, min. setting range is limited as below.)

Record channel	Setting range
1 to 2	01m 00s to 99m 59s
3 to 4	02m 00s to 99m 59s
5 to 6	03m 00s to 99m 59s

Record channel	Setting range
7 to 8	04m 00s to 99m 59s
9 to 10	05m 00s to 99m 59s
11 to 12	06m 00s to 99m 59s

- Factory default: -

8.5.8 Option Period (Option record period)

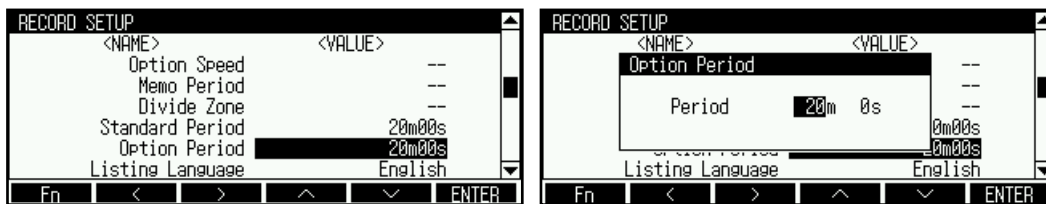

When Record Mode(Record mode) is set as 'Digital', set record period for current time (hh:mm:ss) and measuring value by channel (min:sec) through digital input(Speed set).

- Setting range: 00m 01s to 99m 59s (Depending on the number of recording channel, min. setting range is limited as below.)

Record channel	Setting range
1 to 2	01m 00s to 99m 59s
3 to 4	02m 00s to 99m 59s
5 to 6	03m 00s to 99m 59s

Record channel	Setting range
7 to 8	04m 00s to 99m 59s
9 to 10	05m 00s to 99m 59s
11 to 12	06m 00s to 99m 59s

- Factory default: -

8.5.9 Listing Language (Language for list output)

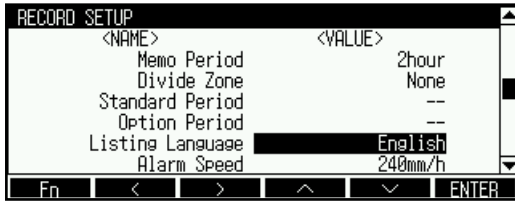

Designate recorded language when list output.

Language	Example of recording
English	<pre> ----- ○ PRINT MODE=DIGITAL 2011/06/14(THU) , 11:35:27 ○ SPEED=STANDARD:240 , ALARM:240 ,OPTION:240mm/H ○ CH INPUT LO_RNG LO_SC UNIT ○ TAG HI_RNG HI_SC FILT ○ 1 TC-K -200.0 1350.0 °C ○ CH-1 1350.0 ○ 2 TC-K -200.0 1350.0 °C ○ CH-2 1350.0 ----- </pre>
Korea	<pre> ----- ○ 프린터방식:=그래프 2011/06/14(목) , 11:35:27 ○ 기록속도=표준:240 알람:240 옵션:240mm/H ○ 채널 입력 하한범위 하한스케일 단위 ○ 이름 상한범위 상한스케일 필터 ○ 1 TC-K -200.0 1350.0 °C ○ CH-1 1350.0 ○ 2 TC-K -200.0 1350.0 °C ○ CH-2 1350.0 ----- </pre>

- Setting range: English ↔ Korea
- Factory default: English

8.5.10 Alarm Speed (Alarm record speed)

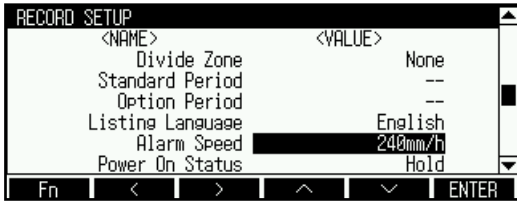

Set record speed for alarm cause and details when alarm occurs.

It is activated when Record Mode(Record mode) is set as Graph.

You cannot set Alarm Speed(Alarm record speed) as below Standard Speed(Standard record speed). If you change Standard Speed, Alarm Speed is changed as the same set value automatically.

When alarm occurs, record progresses with set Alarm Speed. When alarm is reset, it returns to Standard Speed.

- Setting range: 10↔20↔40↔60↔120↔240mm/h
- Factory default: 20mm/h



Note

- If alarm and digital input occur at the same time, digital input is ignored and it records with the set value of Alarm Speed(Alarm record speed). When alarm is reset, it returns to Standard Speed (Standard record speed).

In graph mode, record speed is change by Standard speed, Alarm and Option Speed.

Backup data is printable only with Standard speed. Therefore, original graph mode printout and backup graph mode printout may be different.

8.5.11 Power On Status (Record status when power ON)



Designate one record operation starts from 3 mode for when KRN100 re-turns ON from OFF by power failure.

Hold(Maintain)	Maintains record status of before power OFF (recording or stop recording).
Run(Record)	Operates recording when power is ON.
Stop(Stop recording)	No recording when power is ON.

- Setting range: Hold↔Run↔Stop
- Factory default: Hold

8.5.12 Run Status (List printing at start recording)



Set whether to print setting list when starting recording. When printing list, icon for record in section 1 is changed as  and flashes. After printing list with 240mm/h record speed, it processes record with changed set record speed. Please refer to List Out Option(List record option) for the set list item.

- Setting range: ON / OFF
- Factory default: OFF

8.5.13 List Out Option (List record option)



Select parameter set value recording either Standard or Option and, it starts record.

It is activated when Run Status(List printing at start recording) is set as 'ON'.

Set	Description	Example of recording
Standard	Records standard parameters only.	<pre> PRINT MODE=DIGITAL 2011/06/14(THU) , 11:35:27 SPEED=STANDARD:240 , ALARM:240 , OPTION:240mm/H CH INPUT LO_RNG LO_SC UNIT TAG HI_RNG HI_SC FILT 1 TC-K -200.0 °C CH-1 1350.0 0 2 DPT100 -200.0 °C CH-2 850.0 0 </pre> <p>Input specification(INPUT), channel name (TAG), lower limit input value(LO-RNG), upper limit input value(HI-RNG), display unit(UNIT), input digital filter(FILT)</p>
Option	Records standard parameters and option parameters.	<pre> PRINT MODE=DIGITAL 2011/06/14(THU) , 11:35:27 SPEED=STANDARD:240 , ALARM:240 , OPTION:240mm/H CH INPUT LO_RNG LO_SC UNIT TAG HI_RNG HI_SC FILT ALM1 VALUE RELAY ALK2 VALUE RELAY ALM3 VALUE RELAY ALK4 VALUE RELAY 1 TC-K -200.0 °C CH-1 1350.0 0 DV.Lo 1000.0 None None None None None None None None None None 2 TC-K -200.0 °C CH-2 1350.0 0 DV.Lo 1000.0 None None None None None None None None None None NETWORK : 485 : DISABLE USB-DE : ENABLE E_NET:DISABLE </pre> <p>Input specification(INPUT), channel name (TAG), lower limit input value(LO-RNG), upper limit input value(HI-RNG), display unit(UNIT), input digital filter(FILT), alarm mode(ALM□), alarm set value(VALUE), alarm number(RELAY), communication interface (NETWORK, USB, E_NET)</p>

- Setting range: Standard↔Option
- Factory default: Standard



Note

List is printed with max. record speed (240mm/h). Depending on the number of channel, it may take long time. Therefore, be sure this when printing the list.

8.5.14 Zone Dot Line Distance (Dot line for zone division)



Designate present/absence and interval of dot line at right to divide zone when zone is set. Dot line for zone division is printed in violet.

- Setting range: None to 8.0mm (Set with 0.8mm interval)
- Factory default: 4.0mm



Ex.

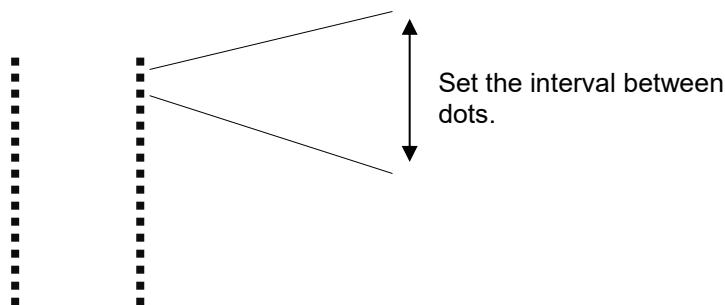

8.5.15 CH Print Distance (Record interval for each channel graph)



Designate the interval for printing channel number of each graph as below figure.

It is activated when Record Mode(Record mode) is set as 'Graph'.

- Setting range: No Print to 100.0mm(Set by 10mm interval)
- Factory default: 20.0mm



8.5.16 Start Line Print (Start line when starting record)

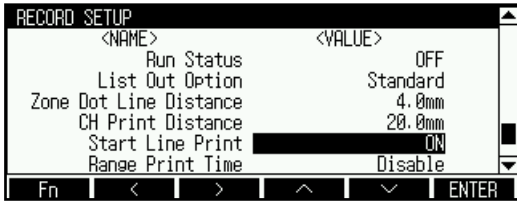

Set whether to draw start line when starting record.



- Setting range: ON ↔ OFF
- Factory default: ON

8.5.17 Range Print Time (Input range record period)



It is actiaved when Record Mode(Record mode) is set as Graph. Set record period of High/Low Range & Graph Scale(High/ Low input value and graph scale value).

- Setting range: Disable ↔ 1 to 24hour
- Factory default: Disable



Ex.

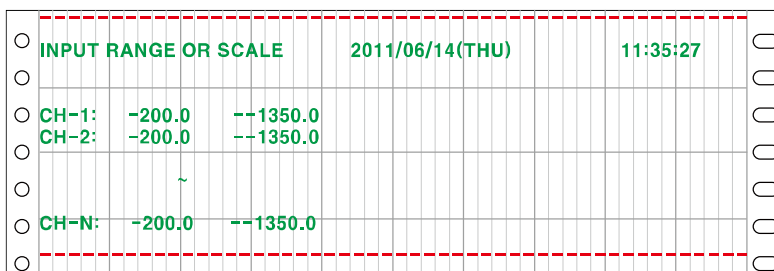

Note

During Range printing, the other data except graph is not recorded within pritted range. Be sure that if there is too many channel numbers or if Range Print Time interval is too short with low speed, various information about channel is not printed at Range print zone.

8.5.18 PenX(color) ON Time (Ink cartridge point delay time)

NAME	VALUE
Pen1(Violet) ON Time	13
Pen2(Red) ON Time	13
Pen3(Black) ON Time	13
Pen4(Green) ON Time	13
Pen5(Blue) ON Time	13
Pen6(Brown) ON Time	13

Fn < > ^ v ENTER

By setting the dot delay time of the ink cartridge, you can adjust the darkness of the ink printed on the paper. The lower the value, the lighter the display, and the higher the value, the darker the display. The higher the value, the shorter the life of the ink cartridge.

- Setting range: 1 to 25
- Factory default: 13





Note

The setting values are maintained even after initialization in the [FILE/MEMORY SETUP-Load Set File] menu. This menu cannot be set by communication.

8.6 SYSTEM SETUP (System setting)

You can set system parameters of KRN100.

Set the item related system (date and time, option, etc).

Move to SYSTEM SETUP with ,  keys, press  key to enter SYSTEM SETUP.

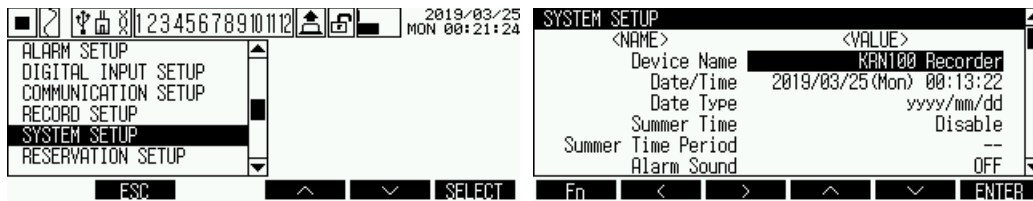

Parameter list

Parameter	Setting range	Factory default
Device Name (Device name)	Max. 16 characters	KRN100 Recorder
Date/Time (Date/Time)	Date: 2000y01m01d to 2099y12m 31d Time: 00h 00m 00s to 23h 59m 59s	Set as factory default
Date Type (Date type)	yyyy/mm/dd ↔ mm/dd/yy ↔ dd/mm/yy	yyyy/mm/dd
Summer Time (Summer time)	Disable ↔ Enable	Disable
Summer Time Period (Summer time period)	01m 01d 00h to 12m 31d 23h	--
Alarm Sound (Alarm sound)	OFF ↔ Min ↔ Standard ↔ Max	OFF
Sampling Rate (Sampling period)	1 channel to 4 channel: 25, 125, 250 5 channel to 12 channel: 125, 250	125ms
Log Speed (Save period)	0 to 3600	None (0s)
Backlight (LCD backlight brightness)	OFF ↔ Min ↔ Standard ↔ Max	Standard
Backlight On/Off (LCD backlight ON method)	Temp ↔ Always	Temp

※ Shaded parameters are affected by set value of other parameters. Please refer to specific descriptions of each parameter.

8.6.1 Device Name (Device name)

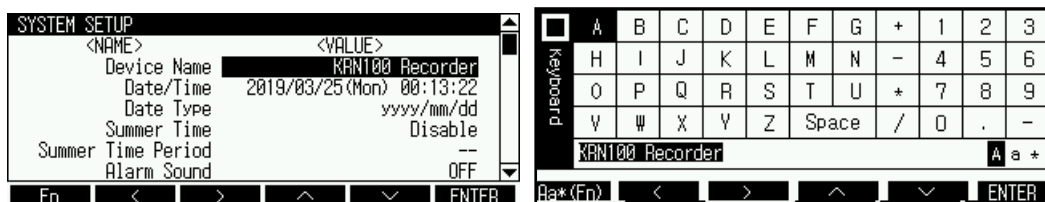

Designate user defined KRN100 name.

It supports up to 16 characters with English capital letters, English small letters, and special letter.

- Setting range: 16 characters
- Factory default: KRN100 Recorder

8.6.2 Date/Time (Date/Time)

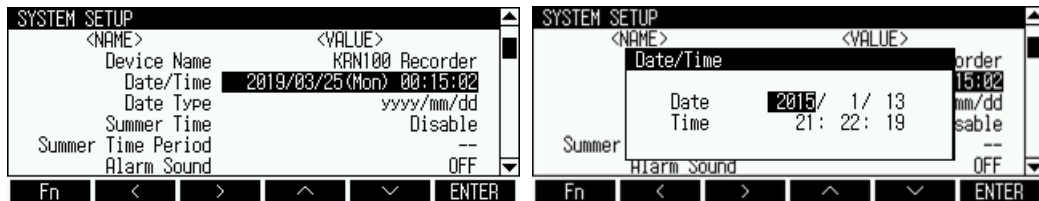

Designate system date and time of KRN100.

When you set the date, the day of week is automatically set and time is displayed in 24-hours format.

Based on set date and time, it records and saves the data.

- Setting range
Date: 2000y01m01d to 2099y12m31d, Time: 00h00m00s to 23h59m59s
- Factory default: Set as factory default

8.6.3 Date Type (Date type)



Set KRN100 system date display method on the screen and record method on the recording paper.

You can select one display method among yyyy(year)/mm(month)/dd(day), mm(month)/dd(day)/yy(year), or dd(day)/mm(month)/yy(year).

- Setting range: yyyy/mm/dd ↔ dd/mm/yy ↔ mm/dd/yy
- Factory default: yyyy/mm/dd

8.6.4 Summer Time (Summer time)



This function is for applying summer time (daylight saving time) in specific countries and regions.

When you set Summer Time, it adds current time and 1 hour and displays '(S)' mark in front of the date and time on LCD screen or in front of the date on recording paper.

- Setting range: Disable ↔ Enable
- Factory default: Disable

8.6.5 Summer Time Period (Summer time period)

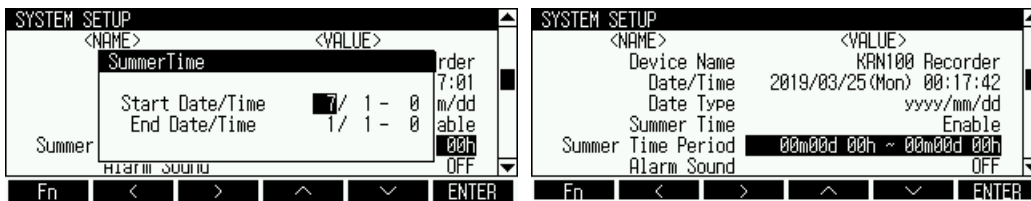

Designate summer time (daylight saving time) period.

When Summer Time is set as 'Enable', it is activated. Designate Start date/Time, and End Date/Time.

- Setting range: 01m01d 00h to 12m31d 23h
- Factory default: --



Note

When changing summer time, it creates new backup data.

8.6.6 Alarm Sound (Alarm sound)



Designate Alarm Sound (alarm sound) level when alarm operation turns ON.

- Setting range: OFF ↔ Min ↔ Standard ↔ Max
- Factory default: OFF

8.6.7 Sampling Rate (Sampling period)



Designate sampling rate (Sampling period) of measuring value.

Setting range may be different by the number of connected universal input card(KRN-UI6).

- Setting range
 - When connecting 1 to 2 universal input card(KRN-UI2): 25↔125↔250ms
 - When connecting 3 to 6 universal input card(KRN-UI2): 125↔250ms
- Factory default: 125ms



Note

Min. sampling period for TC-R, U, S, T sensors is 50ms.

8.6.8 Log Speed (Save period)

SYSTEM SETUP	
<NAME>	<VALUE>
Date Type	yyyy/mm/dd
Summer Time	Disable
Summer Time Period	--
Alarm Sound	OFF
Sampling Rate	125ms
Log Speed	1s

Fn < > ^ v ENTER

Designate the save period of measured data by universal input card (KRN-UI2) to system memory. The recorded data on recording paper is also recorded by save period.

For example, 3 sec save period records every 3 sec data, but it does not record during 3 sec of data which are changed.

- Setting range: 0 to 3600
- Factory default: None (0s)



Note

If save period is set longer, the relation between graph data and alarm ON data is lower because of the occurring alarm record in the middle of save period during recording.

When setting as 'None (0s)' for Log Speed(save period), recording operates normally but the data does not saved at inner/external memory. If no recording paper (P.END) alarm occurs, there is no designated data and backup data is not recorded.

8.6.9 Backlight (LCD backlight brightness)

SYSTEM SETUP	
<NAME>	<VALUE>
Summer Time	Disable
Summer Time Period	--
Alarm Sound	OFF
Sampling Rate	125ms
Log Speed	None
Backlight	Standard

Fn < > ^ v ENTER

Designate LCD backlight brightness as 4 levels.

- Setting range: OFF ↔ Min ↔ Standard ↔ Max
- Factory default: Standard

8.6.10 Backlight On/Off (LCD backlight ON method)

SYSTEM SETUP	
<NAME>	<VALUE>
Summer Time Period	--
Alarm Sound	OFF
Sampling Rate	125ms
Log Speed	None
Backlight	Standard
Backlight On/Off	Temp

Fn < > ^ v ENTER

Designate LCD backlight ON method.

If you set as 'Always', it maintains ON status, as 'Temp', it maintains only for 30 sec when key is input.

- Setting range: Always ↔ Temp
- Factory default: Temp

8.7 RESERVATION SETUP (Reservation setting)

You can set reservation parameters of KRN100.

Set the item related reservation (reservation type, reservation period, reservation time).

Move to RESERVATION SETUP with ,  keys, press  key to enter RESERVATION SETUP.

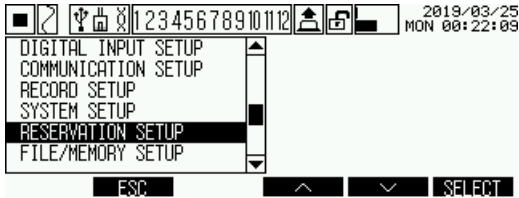

- Parameter list

Parameter	Setting range	Factory default
Reservation Type (Reservation record)	Disable ↔ Single ↔ Repeat	Disable
Reservation Period (Reservation record period)	2000y 01m 01d to 2099y 12m 31d	--
Reservation Time (Reservation record time)	00h 00m 00s to 23h 59m 59s	--



※ Shaded parameters are affected by set value of other parameters. Please refer to specific descriptions of each parameter.

8.7.1 Reservation Type (Reservation record)



This function is to set reservation time. At the set time, it starts/stops recording automatically.

You can select reservation record either Repeat(Repeat ON/OFF) or Single(Single ON/ OFF).

When selecting reservation record, 'Reservation Period(Reservation record period)' and 'Reservation Time(Reservation record time)' are activated. When reservation record is set, **RE** icon flashes with  (recording) or  (stop recording) icon.

RE icon turns OFF when reservation setting is 'Disable'.

- Setting range: Disable ↔ Repeat ↔ Single
- Factory default: Disable

(1) Repeat(Repeat ON/OFF)

From start recording date to end recording date, it records data at from the set start time to the set end time. End time must be later than Start time.



Reservation Period(Reservation record period) setting: Start Date 2011/ 1/ 1, End Date 2011/ 1/ 3
 Reservation Time(Reservation record time) setting: Start Time 12/ 00/ 00, End Time 23/ 59/ 59

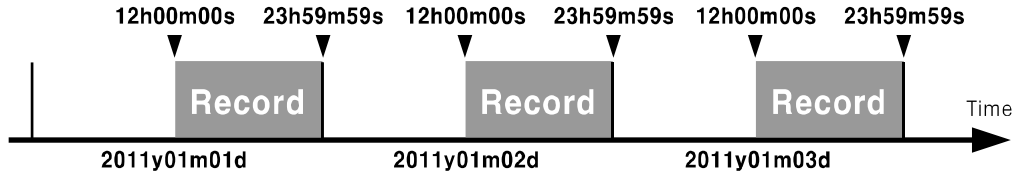

It records data every at from 12:00:00 to 23:59:59 in from 1st, Jan, 2011 to 3rd, Jan, 2011.

(2) Single(Single ON/OFF)

Starts recording at the start set time on start date and finishes recording at the end set time on end date.



Reservation Period(reservation record period): Start Date 2011/ 1/ 1, End Date 2011/ 1/ 5
 Reservation Time(reservation record time): Start Time 12/ 00/ 00, End Time 23/ 59/ 59

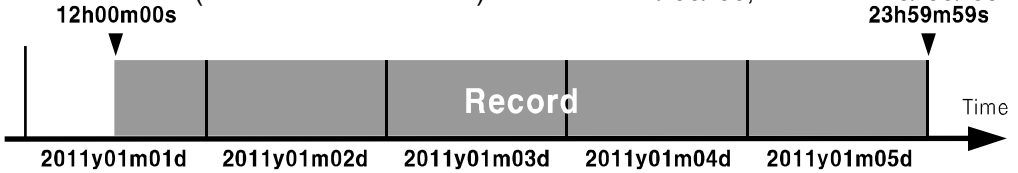

It starts recording at 12:00:00 on January 1st 2011 and finishes it at 23:59:59 January 5th 2011.

8.7.2 Reservation Period (Reservation record period)

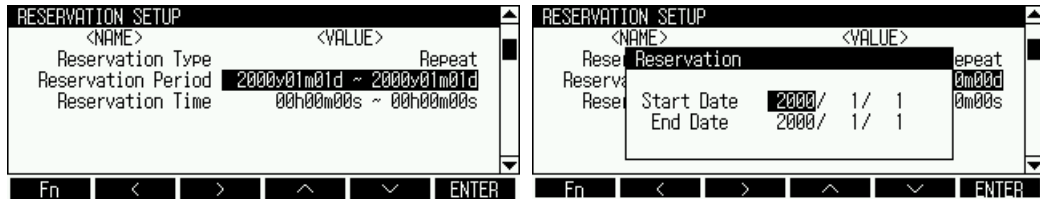

Designate reservation record period. When Reservation Type(Reservation record) is set as 'Repeat(Repeat ON/OFF)' or 'Single(Single ON/OFF)', it is activated to designate Start Date(Start date) and End Date(End date).

- Setting range: 2000 / 01 / 01 to 2099 / 12 / 31
- Factory default: --

8.7.3 Reservation Time (Reservation record time)

RESERVATION SETUP		<NAME>	<VALUE>
Reservation Type		Repeat	
Reservation Period	2000y01m01d ~ 2000y01m01d		
Reservation Time	00h00m00s ~ 00h00m00s		

RESERVATION SETUP		<NAME>	<VALUE>
Rese	Reservation	Repeat	0m00d
Reser			0m00s
Rese	Start Time	0/ 0/ 0	
	End Time	0/ 0/ 0	

Designate reservation record time. When Reservation Type(Reservation record) is set as 'Repeat(Repeat ON/OFF)' or 'Single(Single ON/OFF)', it is activated to designate Start Time(Start time) and End Time(End time).

- Setting range: 0/ 00/ 00 to 23/ 59/ 59
- Factory default: --

Note

If reservation record(Reservation record) is set and during reservation recording, digital input is not available as RUN mode. In stopping recording status by reservation record, it is available.

8.8 FILE/MEMORY SETUP(File/Memory setting)

You can set the parameter about parameter set file and storage data.

Move to FILEMEMORY SETUP with ,  keys, press  key to enter FILE/MEMORY SETUP.

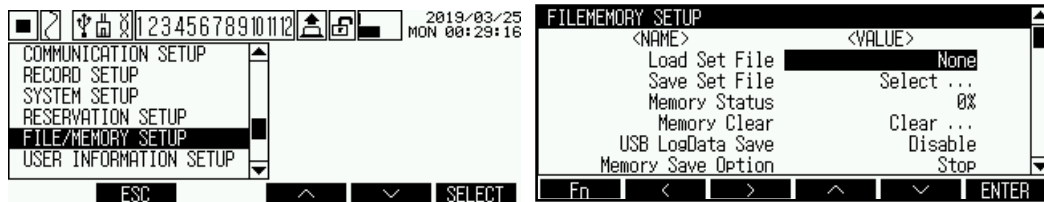

Parameter list

Parameter	Setting range	Factory default
Load Set File (Open parameter setting file)	None, Default.pms, User1.pms, User2.pms, User3.pms, User4.pms, User5.pms, User1.pms(USB), User2.pms(USB), User3.pms(USB), User4.pms(USB), User5.pms(USB)	None
Save Set File (Save parameter setting file)	None, Default.pms, User1.pms, User2.pms, User3.pms, User4.pms, User5.pms, User1.pms(USB), User2.pms(USB), User3.pms(USB), User4.pms(USB), User5.pms(USB)	Select ...
Memory Status (Memory capacity)	0% to 100%(display range)	0%
Memory Clear (Delete memory)	Cancel ↔ All Clear	Clear ...
USB LogData Save (USB storage function)	Enable ↔ Disable	Disable
Memory Save Option (Memory storage option)	Overwrite ↔ Stop	Stop
USB Memory Copy/Move (Move/Copy data)	-	USB Copy/Move ...

8.8.1 Load Set File (Open parameter setting file)

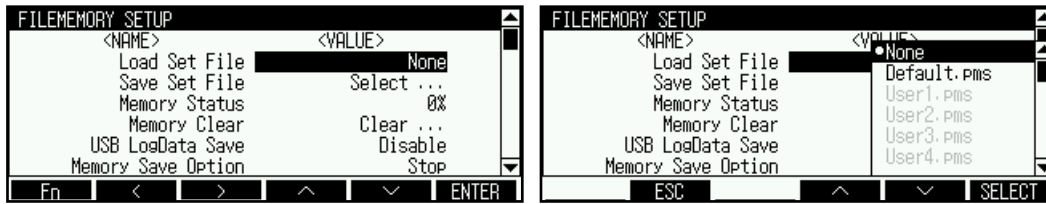

Applies set value of saved parameter set file.

When applying this set, backup data, user unit and booting logo are not changed.

None, Default.pms file is activated and if there is User1.pms to User5.pms, User1.pms(USB) to User5.pms(USB) file(parameter set save file), it is activated.

- Setting range: None ↔ Default.pms ↔ User1.pms to User5.pms ↔ User1.pms(USB) to User5.pms(USB)
- Factory default: None



Caution

Be sure that if selecting 'Default.pms' file, every set value is reset as factory default. Save the current set parameter as Save Set File (parameter setting file storage) at first and reset it for the provision.

User1.pms to User5.pms, User1.pms(USB) to User5.pms(USB) file is selected, all parameter setting information of KRN100 is changed as the set value of the selected parameter save file.

Set value changing may be also affected to every setting of KRN100's overall operations. Check possible problems occurring on system and change the desired set value.

8.8.2 Save Set File (Save parameter setting file)

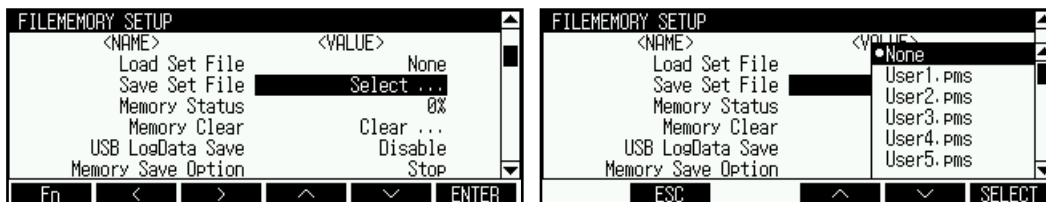

Saves current set parameter set value to User1.pms to User5.pms file of inner memory. In case of empty file, it displays gray.

- Setting range: None ↔ User1.pms to User5.pms, User1.pms(USB) to User5.pms(USB)
- Factory default: Select ...

8.8.3 Memory Status (Memory capacity)

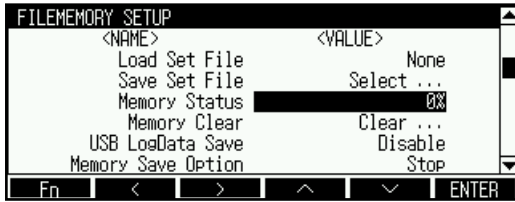

Displays system memory usage in %.

If memory usage is 100%, depending the set value of '8.8.6 Memory Save Option (Memory storage option)', new data is overwritten on oldest backup data or it stops saving backup data.

- Display range: 0 to 100%
- Factory default: 0%



Note

Inner system memory of KRN100 is 512 Mbyte, and KRN100 supports an external USB memory up to 32 Gbyte. Another file to be saved data is created when it is over 100 Mbyte.

Below table is save time for 100Mbyte data by the number of input channels.

The number of CH	Saved time
1 channel	Approx. 50 days
2 channels	Approx. 43 days
3 channels	Approx. 37 days
4 channels	Approx. 33 days
5 channels	Approx. 30 days
6 channels	Approx. 27 days

The number of CH	Saved time
7 channels	Approx. 25 days
8 channels	Approx. 23 days
9 channels	Approx. 21 days
10 channels	Approx. 20 days
11 channels	Approx. 18 days
12 channels	Approx. 17 days

8.8.4 Memory Clear (Delete memory)



Delete the saved log data on system memory.

Current saving backup data is not deleted when deleting backup data.

- Setting range: Cancel ↔ All Clear
- Factory default: Clear ...

8.8.5 USB LogData Save (USB storage function)



Set whether to save backup data which is saved on system on an USB memory.

When selecting Enable to saving data to an USB memory, it also saves data to system memory at the same time. A connected USB memory at left side USB Slot, KRN100 starts to save. It takes check time for storage free space approx. 10 to 60 sec. depending on memory capacity.

The data is saved as 'KRN100_20100815(year month day)_091050(hour min. sec.).KRD' file name and if main set*¹ is changed or backup data capacity is over 100MByte, it creates new file.

- Setting range: Disable ↔ Enable
- Factory default: Disable

※1. Main set is as followings.

Sampling Rate(Sampling period), Display/Temp Unit(Display/Temperature unit),
 Input Type(Input specification), Range/Scale Point(Decimal point),
 Special Function(Special function), High/Low Range & Graph Scale(High/Low input value
 and graph scale value), Low Scale/High Scale(Lower/Upper limit scale value),
 Alarm□ Type(Alarm□ operation mode), Alarm□ Alarm No(Alarm□ output alarm
 number), Record Mode(Record mode), Divide Zone(Record zone division),
 Standard Speed(Standard record speed), Memo Period(Digital memo period),
 Log Speed(Save period), Summer Time(Summer time)



Note

Supporting file system is FAT16, FAT32 when using an USB memory.
 Microsoft's file system, NTFS, and Linux's file system, EXT2, EXT3, etc., are not supportable.

The number of backup data files in the USB memory should be less than 200.

If the number exceeds 200, the device may malfunction.

Be sure to back up the data in the USB memory periodically.

Caution

When connecting an USB memory, KRN100 pauses backup data download by Modbus function, and backup data printer function to recognize memory for a while (depending on the capacity, max. 30 sec).

If an USB memory's LED flashes, do not remove an USB memory, or it may damage to the data. If the damage of USBmemory data occurs, you can find the saved data from KRN100 inner memory and save the desired file to an USB memory.

Set USB LogData Save(USB storage function) as 'Disable' and when the below message disappears, remove an USB memory.



8.8.6 Memory Save Option (Memory storage option)



Set the operation how to storage new data when inner memory storage space is used all as 100%.

Set value	Description
Overwrite	Deletes the oldest backup data file in order and saves new data. Important backup data should be backup at first.
Stop(Stop saving)	Stops backup data. It does not save Backup data. Even though new recording paper is replaced, output function for backup data does not operate.

- Setting range: Overwrite ↔ Stop
- Factory default: Stop

8.8.7 USB Memory Copy/Move (Move/Copy data)

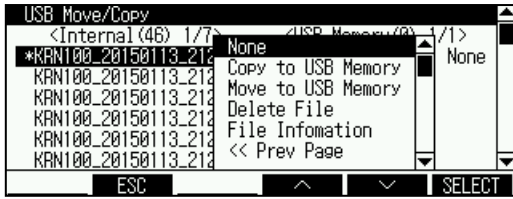

Moves, copies or deletes the saved backup data on inner Memory to an USB memory. Currently saving backup data has '*' mark and it is not able to copy, move and delete.

Item	Description
None	No operation
Copy to USB Memory	Saves selected backup data to an USB memory and preserves backup data of system memory.
Move to USB Memory	Saves selected backup data to an USB memory and deletes backup data of system memory.
Delete File	Deletes backup data.
File Information	Displays backup data information. Displayed information is Name, Path, Size, Log Channel, Log Speed.
<< Prev Page	Moves to previous page of file or directory list.
Next Page >>	Moves to next page of file or directory list.
Up Directory	Moves to parent folder
Into Directory	Moves to sub folder.

- Setting range: (For the desired file) Copy to USB Memory, Move to USB Memory, Delete File
- Factory default: USB Copy/Move ...



Note

- Copy(Move) to USB Memory



- Into Directory

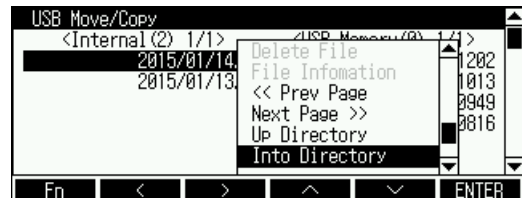

- File Information

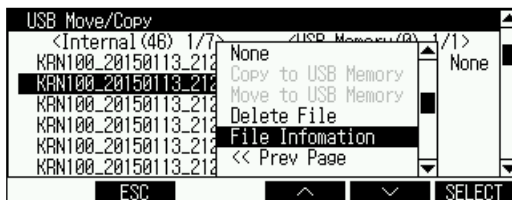

8.9 USER INFORMATION SETUP(User information setting)

You can set user management, check system information, firmware upgrade.

Move to USER INFORMATION SETUP with ,  keys, press  key to enter USER INFORMATION SETUP.

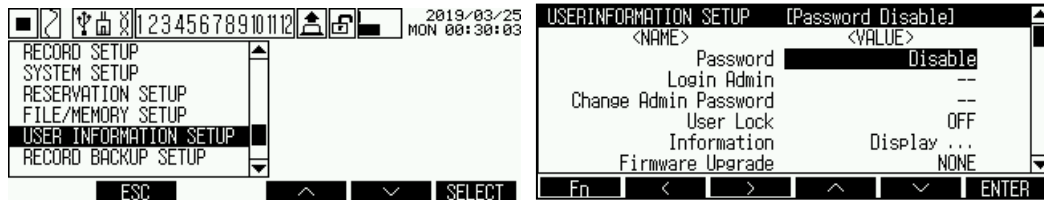

- Parameter list

Parameter	Setting range	Factory default
Password (Password mode)	Disable ↔ Enable	Disable
Login Admin (Administrator log in)	0000 to 9999	-
Change Admin Password (Change password by administrator)	0000 to 9999	-
User Lock (Change user authority)	OFF ↔ LOCK1 ↔ LOCK2, ↔ LOCK3	OFF
Information (Check system information)	-	Display ...
Firmware Upgrade (Firmware upgrade)	-	Automatically display

8.9.1 Password (Password mode)



You can set password and the mode as user(general user) mode and administrator mode to restrict parameter setting and record function.

Administrator has every operate authority and user(general user) has only administrator-defined authority.

Item	Description
Disable	Allows every user operation authorization to use all functions.
Enable	With administrator's or user's log-in and password, allows operation authorization.

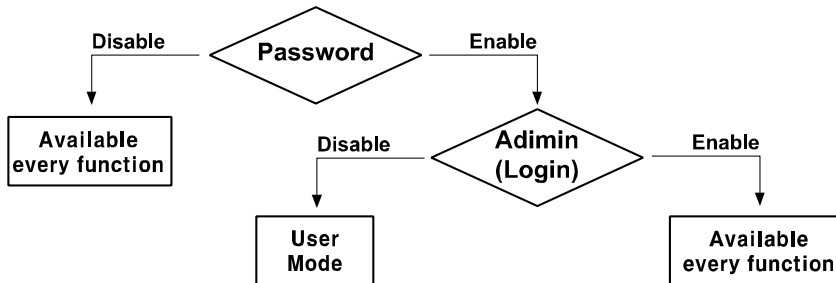

When setting the password, lock icon is displayed. In user(general user) mode, lock icon marks as , and in administrator mode, it marks as .

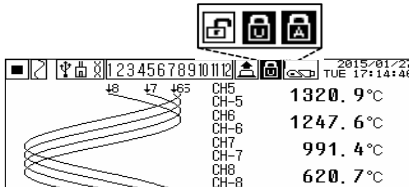

- Setting range: Disable ↔ Enable
- Factory default: Disable

Note

Password mode setting: Disable → Enable is available without authority. But Enable → Disable changing is only available by administrator's authority. Enter the set password at Login Admin to change the mode. In administrator lock state, when power turns OFF/ON, it changes user lock mode.

8.9.2 Login Admin (Administrator log in)

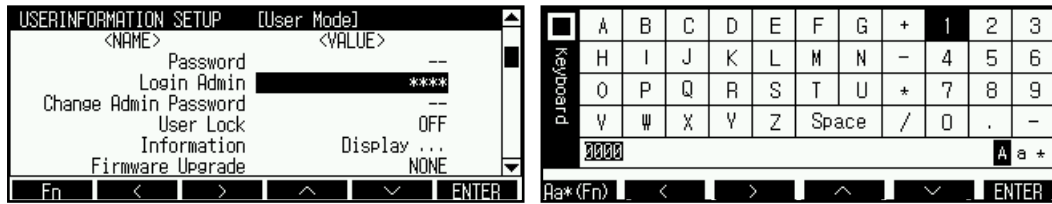

Log in to the parameter by entering password as administrator.

- Setting range: 4 digit number
- Factory default: -



Note

When password is not set yet, default password is "0000".

When entered administrator's password is wrong, it displays 'Fail, ASKey: xxxx'.

Please call our service center (+82-32-820-2356~7) and tell us ASKey and you can check administrator's password.



8.9.3 Change Admin Password (Change password by administrator)

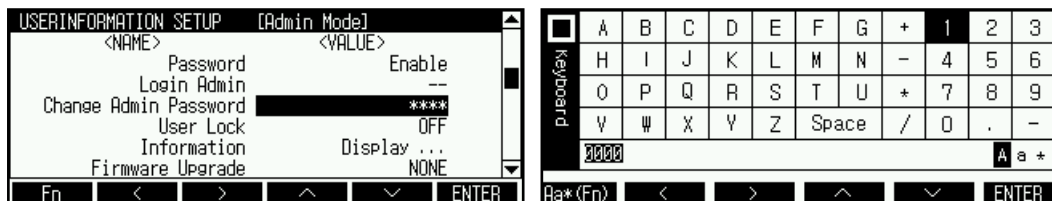

Change the previous password. Changing password is able only when login status as administrator.

- Setting range: 4 digit number
- Factory default: -

8.9.4 User Lock (Change user authority)



User(general user) mode has three levels for function set authority. Settable parameter by function set authority is as below.

Item	OFF	Lock1	Lock2	Lock3
DIGITAL INPUT	●	●	●	▲
ALARM SETUP	●	●	●	▲
INPUT SETUP				
RECORD SETUP				
SYSTEM SETUP	●	●	▲	X
COMMUNICATION SETUP				
RECORD BACKUP DATA				
FILEMEMORY SETUP	●	▲	X	X

●: Enables to check and change set value, ▲: Enables to check set value, X: Disable to check and change set value

- Setting range: OFF ↔ LOCK1 ↔ LOCK2 ↔ LOCK3
- Factory default: OFF



Note

Regardless of User Lock(change user authority) setting, User(general user) mode cannot change firmware upgrade, the set file reset, password mode disable functions.

8.9.5 Information (Check system information)

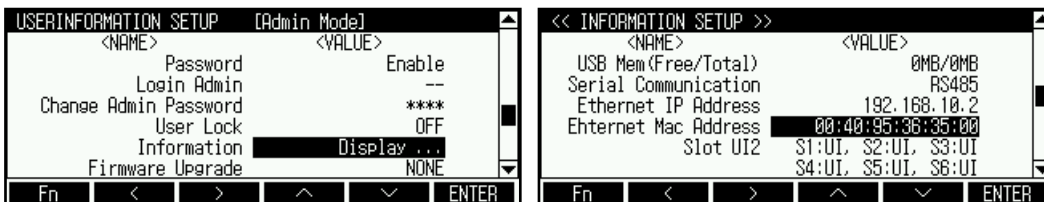

Check system information of KRN100.

You can firmware version, an USB memory capacity, communication concerns, slot connection status, etc.



Note

If connected and displayed card on slot and actual connected card is inconsists, check the connect status of card and re-supply power. If it is not recognized even though re-supplying power, please contact our service center. Autonics service center: +82-32-820-2356~7

8.9.6 Firmware Upgrade (Firmware upgrade)



Updates KRN100 firmware.

When upgrading firmware, parameters' set values are reset.

- Setting range: -
- Factory default: Automatically set



Note

Firmware upgrade

Visit our homepage (www.autonics.com) to download 'KRN100 firmware file (krn100.fwu)'.

1st

Copy the downloaded firmware file to an USB memory's root (top) directory and connect an USB memory to KRN100.

2nd

Check that firmware is recognized on "USERINFORMATION SETUP -Firmware Upgrade" menu.

3rd



4th

Check current version's date and to-be upgraded version's date. Select 'Upgrade' button and it starts firmware upgrade.



Before processing, warning message appears. Select 'OK'.



After completing firmware upgrade, below message appears. Turn OFF the power and turn ON it again.

5th



At first booting after upgrade, reset and delete every parameter set file (Inner default set file, User1.pms to User5.pms) to consider firmware version information print, and compatibility with previous parameter setting.

6th



Caution

During firmware upgrade, alarm output, digital input and log file save, etc functions does not operate normally. Therefore, please take proper measure to prevent malfunction of KRN100 system before starting firmware upgrade.

After completing firmware upgrade, you must turn OFF and ON the power of KRN100 to operate normally.

In process of firmware upgrade, when power turns OFF, firmware upgrade is not complete. When power turns ON again, KRN100 operates with previous firmware version. Try firmware upgrade again.

After completing firmware upgrade and OFF/ON the power, if KRN100 displays booting screen and does not operate normally, it may have damage to the inner firmware during firmware upgrade. It is required to repair.

Please contact our service center. Autonics service center: +82-32-820-2356~7

8.10 RECORD BACKUP_SETUP (Backup data record setting)

Record Backup creates file when power ON regardless of starting/stopping record and saves the data to inner system memory (An USB memory storage is available (Enable) by the set.) according the set record mode.

This parameter is useful to print the desired time data with backup data or check data by computer with DAQMaster (dedicated software).

Therefore, backup data set function is for printing the saved backup data at inner system memory and an USB memory.

Move to RECORD BACKUP SETUP with ,  keys, press  key to enter RECORD BACKUP SETUP.



- Parameter list

Parameter	Setting range	Factory default
Record Backup (Backup data record)	Stop ↔ Start	Stop
Backup Data List (Backup data list)	-	File Not Found!!
Start Date and Time (Start time for data storage)	Date: yyyy/ mm/ dd, Time: hh: mm :ss	0000/00/00 00:00:00
End Date and Time (End time for data storage)	Date: yyyy/ mm/ dd, Time: hh: mm :ss	0000/00/00 00:00:00
Backup Print Mode (Backup data record mode)	-	Graph
Select Print Mode (Backup data recording mode setting)	Graph ↔ Digital	Graph



Note

- When printing with backup data, the saved data in backup data is accurate but backup data printout may not be same 100% with the real-data due to the difference between printing time and backup time. Please use backup data as only for reference.
- For printing backup data, KRN100 reads saved backup data in memory from beginning to end at first and starts printing. If backup data section is long or backup data is saved as low speed record mode, reading takes a lot of time. Therefore, print only for the desired section.
- In graph mode, record speed is changed by Standard speed, Alarm, or Option Speed. Backup data is printed with Standard speed. Therefore, original printout and backup printout in graph mode may be different.

8.10.1 Record Backup (Backup data record)

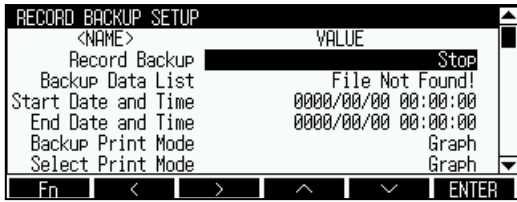

Designate whether recording saved backup data.

Item	Description
Stop	Not printing the designated backup data on Backup Data List, it returns to RUN mode.
Start	Records the designated backup data on Backup Data List from start date and time to end date and time and returns to RUN mode. At RUN mode, the icon for record changes as RECORD BACKUP and flashes. KRN100 reads backup data to the end and starts recording. (Depending on backup data file size, reading time may take longer.)

When starting printing by Record Backup function, starts recording as below figure.

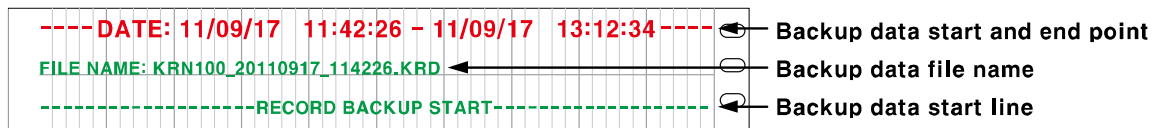

- Setting range: Start ↔ Stop
- Factory default: Stop

8.10.2 Backup Data List (Backup data list)

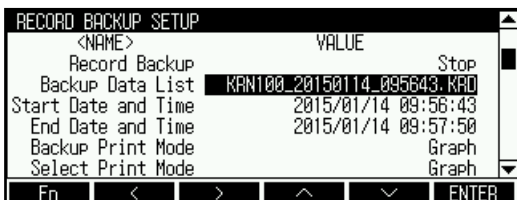

You can check saved Backup Data List(Backup data list).

Backup Data is sorted automatically according to the recently occurring order.

For the information of file selection of backup data list, please refer to '8.10.6 Select Print Mode (Backup data recording mode setting)'.

8.10.3 Start Date and Time (Start time for data storage)

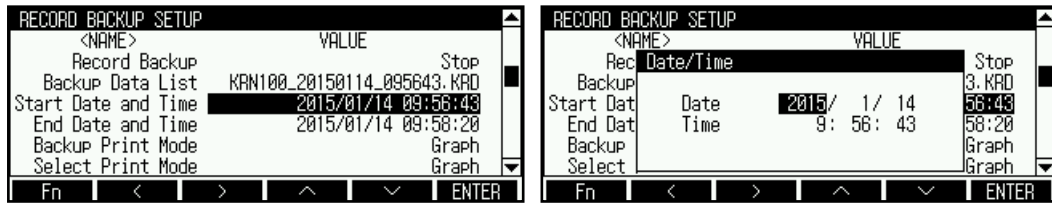

Set storage start date and time for backup data. You can set start date and time.

Setting range is within start date and time to end date and time.

- Setting range
Date: yyyy/ mm/ dd, Time: hh: mm :ss
- Factory default: 0000/00/00 00:00:00

8.10.4 End Date and Time (End time for data storage)



Set storage end date and time for backup data. You can set end date and time.

Setting range is within start date and time to end date and time.

- Setting range
Date: yyyy/ mm/ dd, Time: hh: mm :ss
- Factory default: 0000/00/00 00:00:00

8.10.5 Backup Print Mode (Backup data record mode)

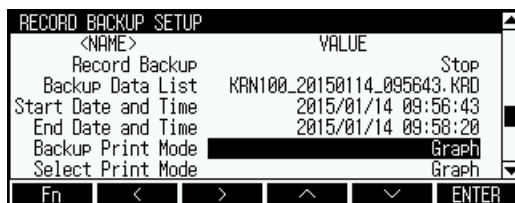

You can check record mode of current saved backup data.

8.10.6 Select Print Mode (Backup data recording mode setting)

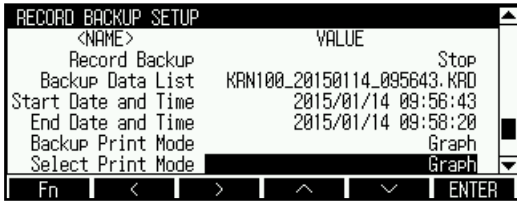

It is able to print with different record mode from original backup data's record mode.

- Setting range: Graph ↔ Digital
- Factory default: Graph



Note

To print with different record mode from original backup data's record mode, it records with the set record speed (in case record mode is Graph) or the set record period (in case record mode is set as Digital) from record mode (Digital or Graph) on current record setup.

For example, in case original backup data is saved as Digital mode (Backup Print Mode: displays digital). To print with Graph mode (Select Print Mode: set as Graph), Graph mode's record speed follows the set record speed of graph mode in current record setup.

- How to select record backup file

Move to RECORD BACKUP SETUP parameter setting group.

1st



2nd In Backup Data List, press  key and system memory and the saved backup data in USB are also display. (If backup data is not designated or does not exist, it displays "File Not Found!".)





3rd Select the desired file in Backup Data List and press  key and menu is displayed.

(Marked '*' files displays currently saving file.)



4th In menu screen, select Select File and press  key and "S" is displayed in front of backup data. Select currently saving file, it displays only '*'.

Press  key to operate Function key and press  key to enter and it selected.

File Information: Checks Backup Data information

Prev Page, Next Page: Moves page (If there are lots of files)

Up Directory: Moves parent folder

Into Directory: Enter the folder

5th You can check save time information of the selected Backup Data.



- Moves parent folder

Press  key in selected file to activate selected screen. Select 'Up Directory' and it moves to parent-folder.

1st



2nd

To moving parent-folder, you can check folders by created date.



3rd

To move desired date folder, press  key at the selected folder and menu screen is activated. Select 'Into Directory' in this menu, it moves to inner folder.

4th



Below screen shows inner folder and saved files.



9 DAQMaster

9.1 Overview

DAQMaster is integrated device management program and is able to utilize for temperature controller product line, meter product line, counter product line and recorder product line, etc.

DAQMaster provides graph user interface (GUI) for easy and convenient integrated several products' parameter setting and data monitoring.

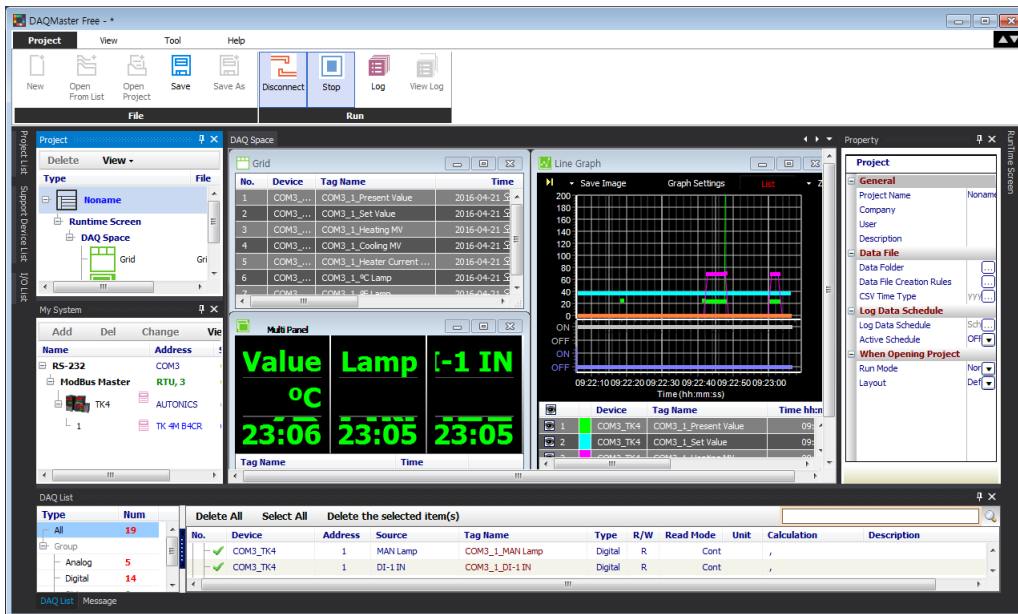

Note

Visit our homepage (www.autonics.com) to download 'DAQMaster user manual'.

This 'KRN100 user manual' describes only for dedicated KRN100 functions. For more information about DAQMaster, please refer to 'DAQMaster user manual'.

9.2 Features

(1) DAQMaster Pro Version Feature

- Data Base
Database managing system (Access, MySQL, SQL Server, Oracle, SQLite) turns information into database in real-time, making creation and management of database easier.
- Real-time Logging
At the set cycle and condition, real-time log file is generated in CSV file.
- Modbus Device Editor
You can add the any modbus devices which are not supported at DAQMaster to set and monitor the property and I/O.
- OPC Client
It is Interface method for better compatibility among application programs based on OLE/COM and DCOM technology of Microsoft. It provides industry standard mechanism for communication and data conversion between client and server.
- DDE Client
It supports communication (IPC) among process embedded in Microsoft Window system, allowing application programs to share and exchange information. This function uses shared memory and provides a common protocol (instruction set and message format) to application programs.

(2) Features

- Multiple Device Support
Simultaneously monitor multiple devices and set parameters. Simultaneously connect units with different addresses in a single device. Multiple RS-232 ports are available for communications using Modbus remote terminal unit.
- Device Scan
In cases of multiple units (with different addresses) connected together, the unit scan function automatically searches for units.
- Convenient User Interface
Freely arrange windows for data monitoring, properties, and projects. Saving a project also saves the screen layout.
- Project Management
Saving data as a project file includes added device information, data monitoring screen layouts, and I/O source selection. When you open the project file, the last state of the saving moment will be loaded. Organizing project list makes managing project files easier.

- **Data Analysis**

Performs grid and graph analyses of data files (*.ddf) using data analysis feature of DAQMaster. Saves grid data in .rtf, .txt, .html, or .csv files in Data Grid.
- **Monitoring Data Log**

When monitoring, data log files can be saved in either DAQMaster data files (.ddf) or CSV (.csv) files. Open files saved in .csv format directly from Microsoft Excel. Define log data file naming/saving rules and destination folders to make file management convenient.
- **Tag Calculation Editing**

Read tag value is available to calculate the set formula for the desired value.
- **Print Modbus Map Table Report**

Print address map reports of registered Modbus devices. Modbus map table reports can be saved in html (*.html) and pdf (*.pdf) formats.
- **Multilingual Support**

Supports Korean, English, Japanese, and Simplified Chinese. To add a different language, modify the files in the Lang folder rename, and save.
- **Script Support**

Uses the Lua Script language and deals with different I/O processes for individual devices.

9.3 DAQMaster Function Comparison Table by Version

Functions	General version	Pro version
Modifying parameter	○	○
Data monitoring	○	○
Data log	○	○
Tag calculation editing	○	○
Trigger	X	○
Data analysis	○	○
Analysis spread	X	○
User Modbus Device Editor	X	○
Script Editor	X	○
Database Device	X	○
DDE Server	X	○
TCP/IP Server	X	○
DDE Client	X	○
OPC Client	X	○
WMI Manager	X	○
Realtime Log (CSV)	○	○
Realtime Log (DB)	X	○
SQL Server	X	○
Oracle	X	○
MySQL	X	○
PostgreSQL	X	○
SQLite	X	○
Nexus DB	X	○
Inter Base	X	○
Firebird	X	○
ODBC	X	○
MS Access	X	○
Sybase ASE	X	○
Sybase ADS	X	○
DB2	X	○
DBF	X	○

9.4 Dedicated KRN100 functions

Among DAQMaster's functions, there are dedicated KRN100 functions during communicating with DAQMaster

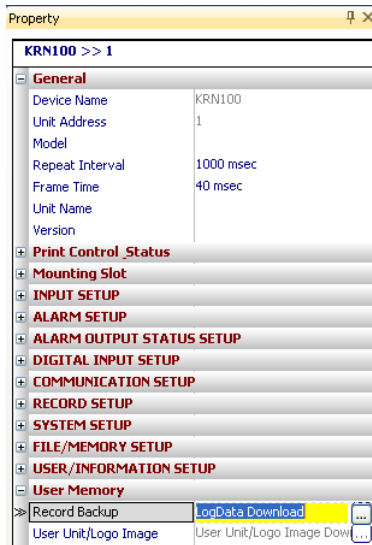

9.4.1 Record Backup

You can download backup data which is saved in KRN100 inner memory from "Record Backup" section.

Directory form is year, month, day. Click the relevant icon and check below list.

To download backup file, click the file name with right mouse button and select "Download Log File" menu.

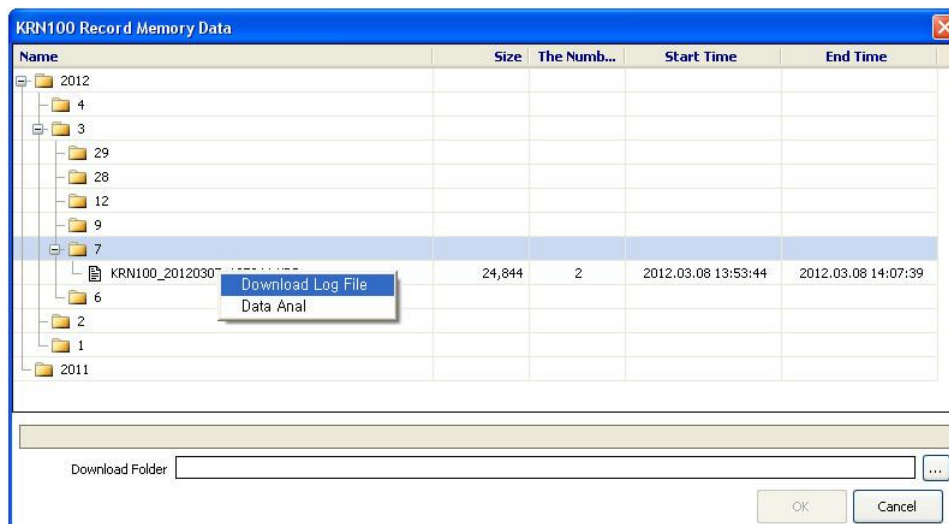

Backup files are structured as tree type directory at KRN100 inner memory. You can easily find and download the desired file.

Note

When checking backup data by DAQMaster, it may not be same as original print out 100%. Therefore, please use backup data as reference.

9.4.2 User unit setting

Total 3 sizes user units are needed; two for display output, one for printing.

Image type	Size
Unit image for printing	32×10(small unit)
Unit image in several channel for displaying	32×12(middle unit)
Unit image in 1 channel for displaying	72×64(large unit)

- How to register user unit image

Make 3 sizes images (file type: bmp) using image tools.

Double-click the arrow area as below figure and select the desired image files.

1st
2nd

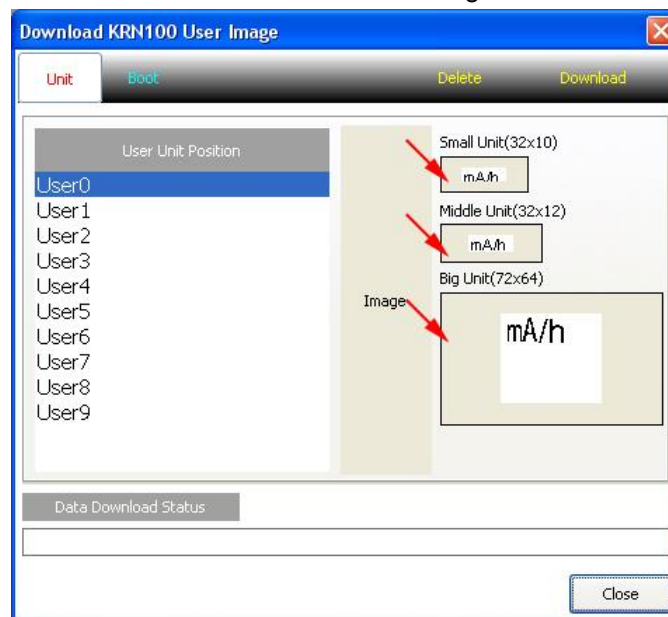

If you not select the image, this unit is proceses as blank.

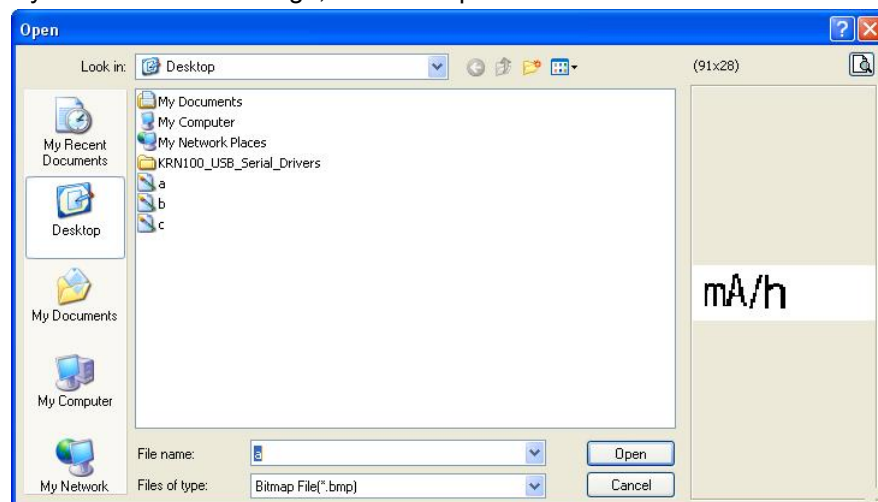

Select image files by type and size, click “Download” to download user images.

3rd

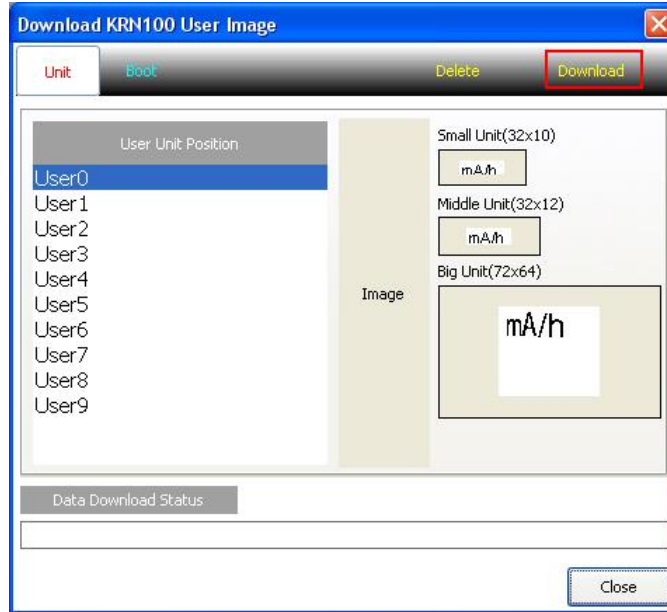

9.4.3 Boot logo image setting

You can set boot logo image to display during KRN100 booting.

After making '320×120' size image with image tools and download it.



9.4.4 Backup data checking function

This function is output downloaded backup data by DAQMater or an USB memory.

Execute Data Anal. At taskbar, click [Start]-[Program]-[DAQMaster]-[DataAnal] or at DAQMaster menu, click [Tool]-[Data Anal].

1st

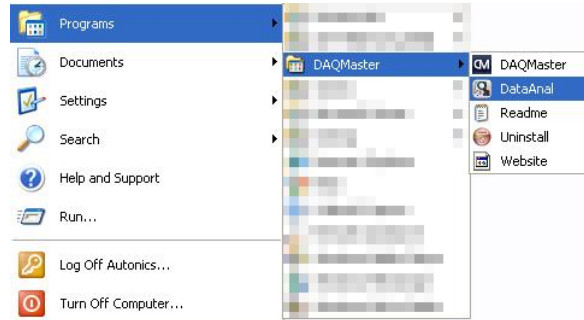

'Data Anal' program opens. Click open file icon and select downloaded ".KRD" file.

2nd

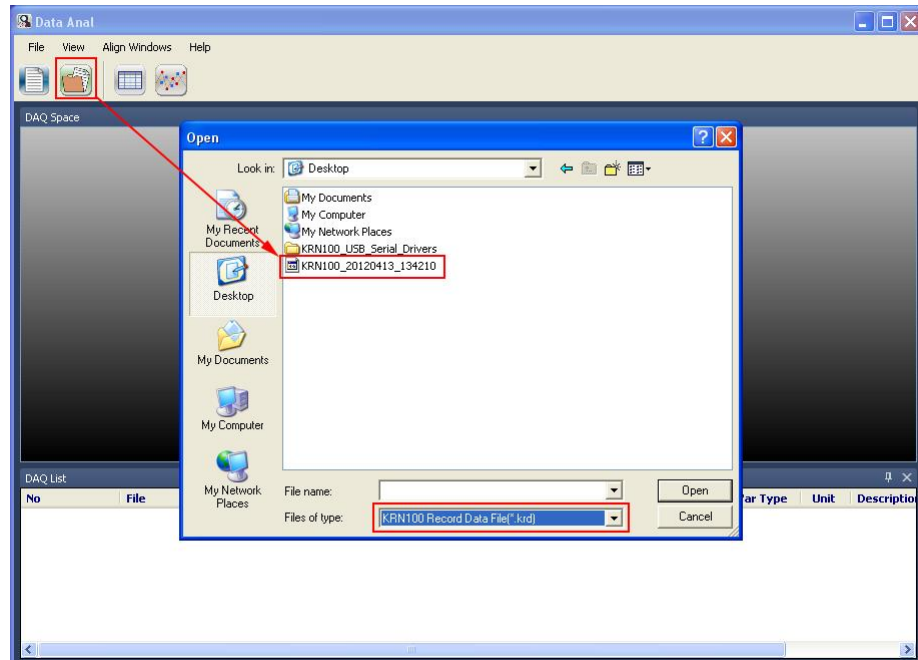

Open chart and drag the desired channel to check waveforms or values.

3rd

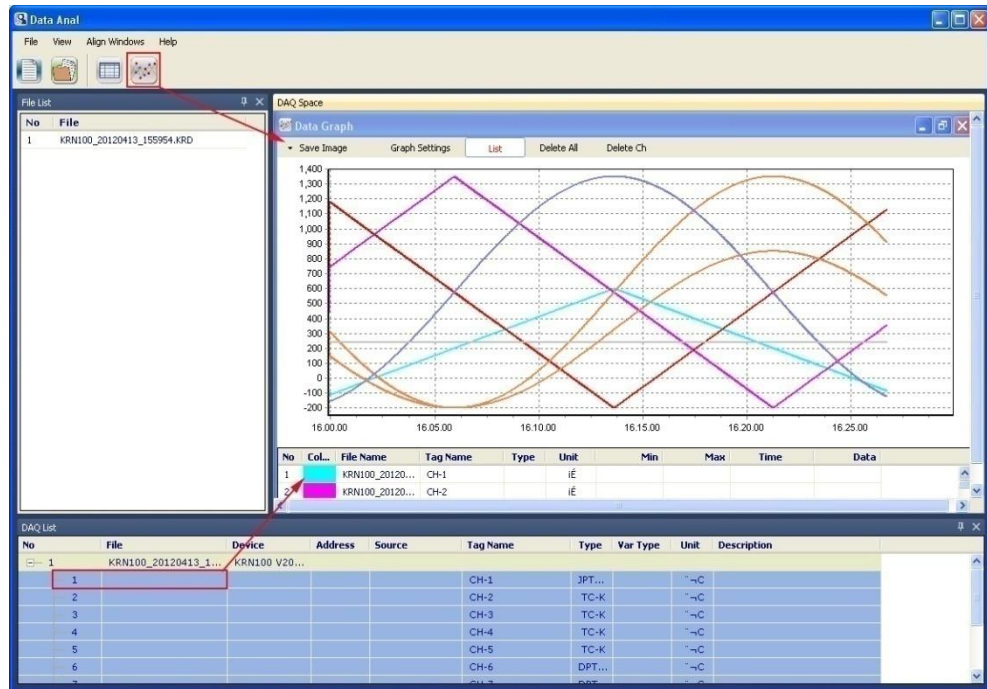

For more information, please refer to 'DAQMaster user manual'.

Note

When checking backup data by DAQMaster, it may not be 100% same with original print out. Please use backup data only for reference.

10 Maintenance

10.1 Ink cartridge replacement

Press  key for 3 sec. in stop recording state and Ink cartridge moves to the center to be replaced easily. Open front cover of KRN100.

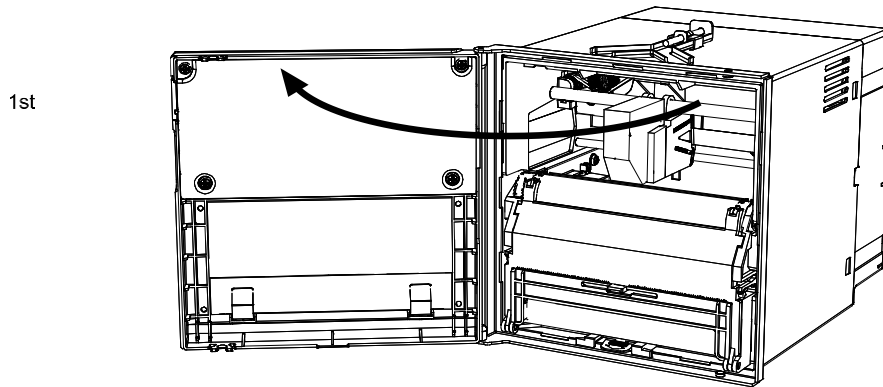

2nd

Push down recording paper cassette lever placed at below recording paper cassette, recording paper cassette is removed from KRN100.

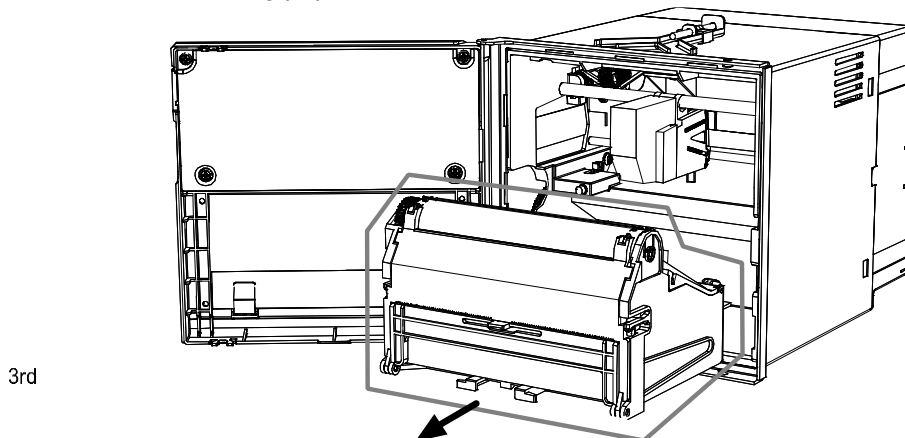

Pull out ink cartridge and it is removed from KRN100.
Insert new ink cartridge.

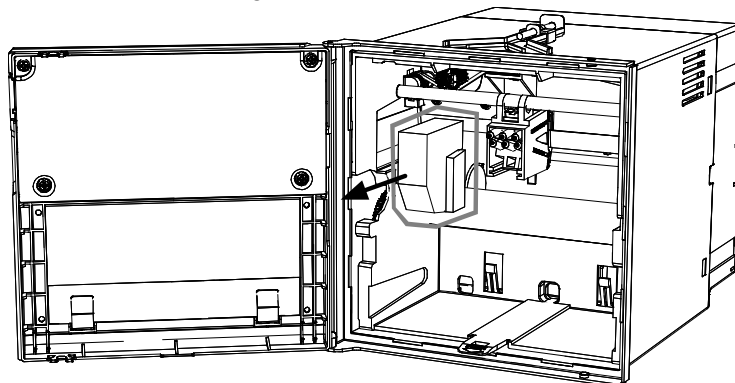

10.2 Recording paper replacement

From 1st to 2nd steps are same as Ink cartridge replacement method. Please refer to this.

Below figure is detached recording paper cassette.

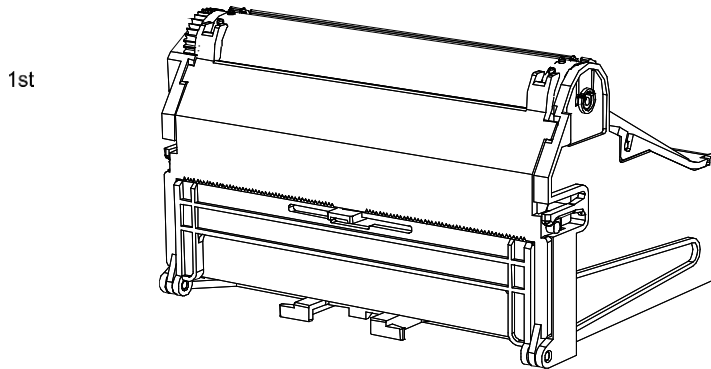

Open new recording paper storage cover and finished recording paper storage cover of recording paper cassette.

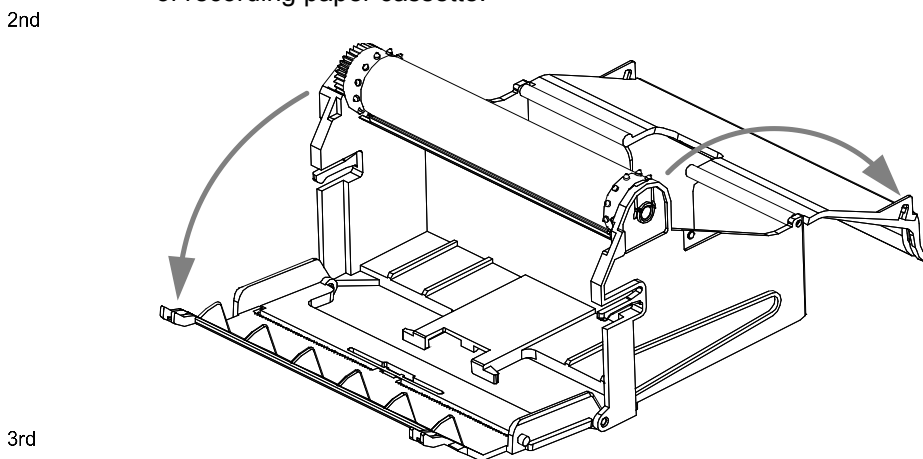

3rd

For better print, recording paper should be loosen by entering the air.
If not as below figure, it may cause paper jam.

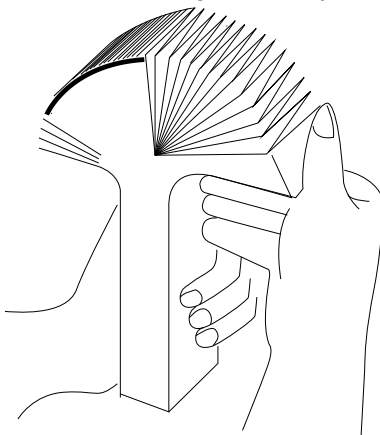

Remove finished recording paper in finished recording paper storage and replace ne recording paper.

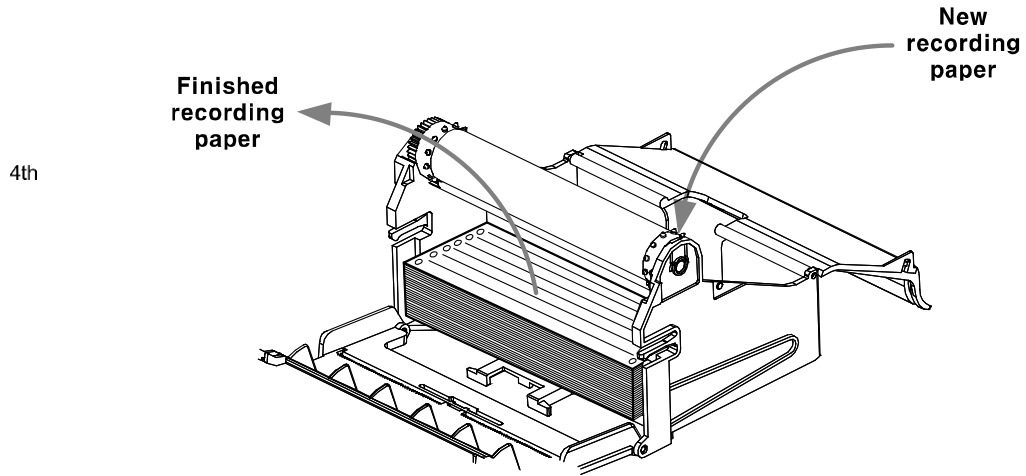

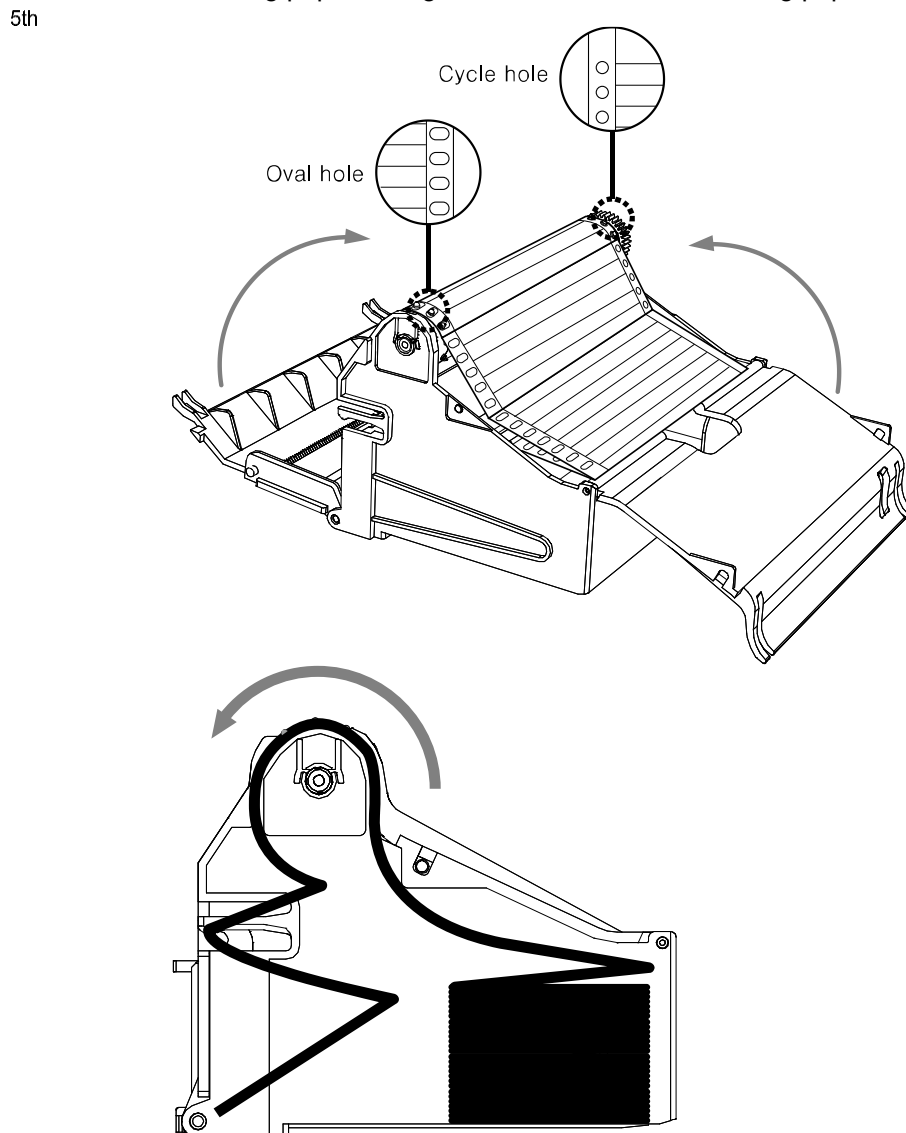

Put recording paper's holes (circle, oval) at recording paper holder and close new recording paper storage cover and finished recording paper storage cover.

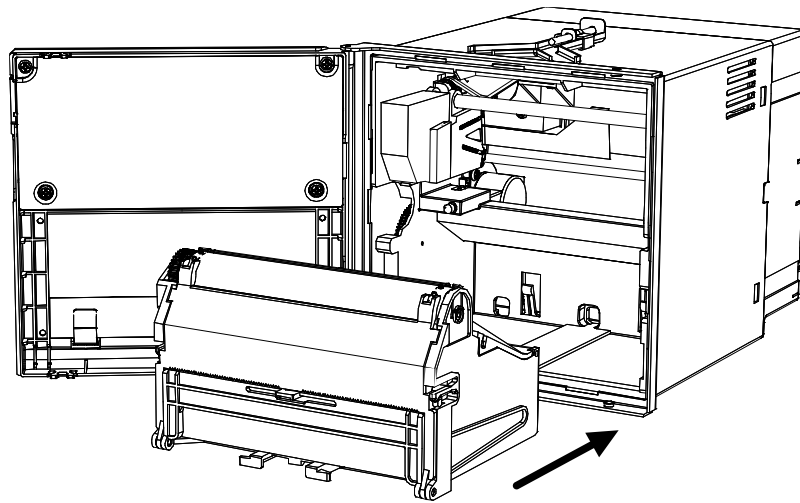

Push recording paper cartridge into KRN100 until click sound. Close front cover of KRN100.

6th





Check recording paper operates normally by pressing front  key with FEED function in stop recording state.

7th

11 Troubleshooting

Check KRN100 normal operation regularly.

No	Error	Troubleshooting
1	When power ON, KRN100 does not display anything on LCD screen and operate.	Check power supply and power connector is connected normally.
2	Displayed date and time is not correct.	KRN100 has date and time error within ± 2 min/year (Useable until in 2100). Set date and time again.
3	Sensor input value is not right.	Check sensor input settings are correct in INPUT SETUP. Turn OFF the power of KRN100 and remove input cards from KRN100 and check jumper pin settings according to input specification.
4	KRN100 records former digital data not current time's.	Displaying record memory status icon ( or ) is the state of recording former digital data. Because there are lots of alarms and record events or recorded data is accumulated due to short memo period. To cancel former data recording, pause and re-start record. Change the settings about record for proper operation.
5	In graph mode, printout for line and letters is not clear and spread.	Replace ink cartridge.
6	Recording paper's terminal mark, red star shape, is displayed.	Recording paper should be replaced. Present recording paper lefts only 330mm from terminal mark.
7	When power ON, after booting screen, KRN100 does not change normal operation screen.	SD card of inner KRN100 has problem. Please contact our service center.
8	USB memory is not recognized.	USB memory's file system supports only FAT16 and FAT32. Format as FAT16 or FAT32. If partitions of an USB memory are divided, KRN100 recognizes only first partition.
9	Cannot connect communication by Ethernet.	Check communication line connection and reset it as following '8.4 COMMUNICATION SETUP (Communication setting)'.
10	Cannot connect communication by RS485 communication.	Check communication line's A, B signal polarity is connected correctly. Reset it as following '8.4 COMMUNICATION SETUP (Communication setting)'.

11.1 Error message

Displays error messages on screen and print data when error occurs.

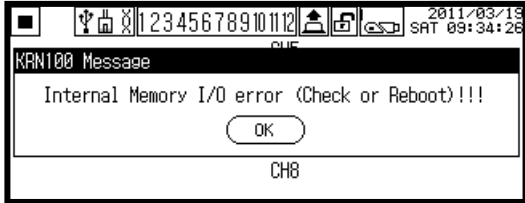
Error message	Description
HHHH	In case Input Type is temperature sensor(thermocouple, RTD), if input value is higher than upper limit range, this error message flashes. If input value is within upper limit range, it is removed automatically.
	In case Input Type is analog(current, voltage), if input value is higher than over 10% of upper limit input range, this error message flashes. If input value is within 10% of upper limit input range, it is removed automatically.
	Prints HH.
LLLL	In case Input Type is temperature sensor(thermocouple, RTD), if input value is lower than lower limit range, this error message flashes. If input value is within lower limit range, it is removed automatically.
	In case Input Type is analog(current, voltage), if input value is lower than over 10% of lower limit input range, this error message flashes. If input value is within 10% of lower limit input range, it is removed automatically.
	Prints LL.
_H	In case Input Type is analog(current, voltage), if input value is higher than below 10% of upper limit input range, "_H" is displayed with current value to notify that current value is higher than upper limit input range. E.g.) When upper limit input range is 100 and current value is 102, it displays as 102_H.
_L	In case Input Type is analog(current, voltage), if input value is lower than below 10% of lower limit input range, "_L" is displayed with current value to notify that current value is lower than lower limit input range. E.g.) When lower limit input range is 0 and current value is -1, it displays as -1_L.
BURN	If input is break, this error message flashes. When input is connected, it is removed automatically.
	Prints BH(display value by break is High) or BL (display value by break is Low). Refer to '8.1.19 Burnout Action (Display setting for break)'.
NONE	If universal input card is not connected, this error message flashes.
ERR	When there is parameter setting error, card recognition error, etc, this error message flashes twice and KRN100 returns to previous screen.
Inner Memory Access	 <p>The screenshot shows a KRN100 Message dialog box with the text 'Internal Memory I/O error (Check or Reboot)!!!' and an 'OK' button. The background shows a control panel with a numeric keypad (0-9) and various function keys. The top right corner of the screen displays the date '2011/03/18' and time 'SAT 09:34:26'.</p>
	As above screen, if excess error message for inner system memory Read/Write occurs frequently, please contact our service center.

Make Life Easy: **Autonics**